



Sample Preparation Products General Catalog

Introduction

| | |
|------------------------------|---|
| Contents | 2 |
| QC | 3 |
| InertSep Format Guide | 4 |
| Selection Overview | 6 |
| InertSep Sorbent Guide | 8 |

1

InertSep

| | |
|--|----|
| Polymer-Based SPE (Reversed Phase) | 12 |
| Polymer-Based SPE (Ion Exchange) | 16 |
| Polymer-Based SPE (Chelate) | 24 |
| Silica-Based SPE (Non-Polar) | 26 |
| Silica-Based SPE (Polar) | 36 |
| Silica-Based SPE (Ion Exchange) | 45 |
| Specialty SPE | 54 |

2

Accessories for SPE

| | |
|-----------------------------|----|
| Vacuum Manifold | 64 |
| Reservoir and Adaptor | 68 |
| Tube | 70 |
| Gravity Flow Manifold | 72 |
| Other Accessories | 75 |
| Syringe Filter | 76 |

3

Life Science

| | |
|--|----|
| Filter Plate | 78 |
| Monolith Silica | 80 |
| MonoSpin | 81 |
| SPE Tip Columns for Trace Samples | 85 |
| Exosome | 86 |
| MonoSpin ProA, MonoSpin ProG, MonoSpin ProL | 88 |
| Phosphorylation Purification & Enrichment | 90 |
| Tip Columns for Enrichment of Phosphopeptides | 93 |
| Desalting and Enrichment Phosphopeptide/Fractionation Tips | 94 |

4

Cat.No. Index

| | |
|-------|----|
| | 96 |
|-------|----|

ISO Certification



GL Sciences Fukushima Factory and General Technical Center are ISO14001 - Compliant Facility

Product Ranges: Design & Development, manufacture, stocking and selling of instruments, parts, accessories, columns, packing materials, reagents relating to gas chromatography, liquid chromatography and cells for spectrometry.



GL Sciences Fukushima Factory and R&D Dept. are ISO9001 Compliant Facility

Product Ranges: Design & Development, manufacture, stocking and selling of instruments, parts, accessories, columns, packing materials, reagents relating to gas chromatography, liquid chromatography and cells for spectrometry.



General Technical Center



Fukushima Factory

Quality Control

Certificate of Analysis

InertSep™ C18 1g / 6mL

Serial No. 16L0000
Sorbent Lot.No. 6100000

Analysis of Silica Gel

| | Specifications | Results |
|-------------------------------|-------------------------------|---------|
| Particle Size | [µm] 45 - 60 | 52 |
| Surface Area | [m ² /g] 400 - 550 | 474 |
| Pore Diameter | [nm] 5.5 - 7.5 | 6.2 |
| Pore Volume | [mL/g] 0.60 - 0.80 | 0.74 |
| Metal Impurity [Fe] (ICP-AES) | [ppm] < 100 | 9 |

Analysis of InertSep C18

(Functional group : Octadecyl(trifunctional))

| Carbon Content | [%] | 17.5 - 20.5 | 18.0 |
|----------------|-----|-------------|------|
|----------------|-----|-------------|------|

Contamination Test

| Sorbent | GC/FID | Pass |
|---------|--------|------|
| Tube | GC/FID | Pass |
| Frit | GC/FID | Pass |

Chromatogram

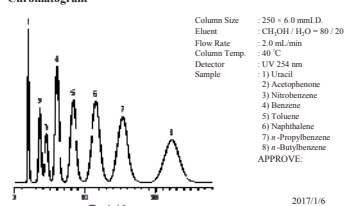

GL Sciences

22-1 Nishiazabu 6-chome, Shibuya-ku, Tokyo 152-1102, Japan
International Department TEL: +81-3-5222-6222 / Fax: +81-3-5222-6221

Quality Control of InertSep Products

The InertSep series is an original GL Sciences brand produced in our own factory through development, manufacturing, quality control and inspection. Our Fukushima Manufacturing factory has obtained the International Organization for Standardization ISO-9001 certification. All solid-phase extraction products are manufactured under strict quality control and widely used in the analysis of food and water samples. All products are inspected and only those which pass our stringent criteria are shipped to customers. On request, we can provide a customization service and custom-made multi-sorbent beds in a cartridge.

InertSep Format Guide

96-well Plates Type

Cartridge volume : ① 1.2 mL ② 800 μ L
 Cartridge material : PP housing and PE frit

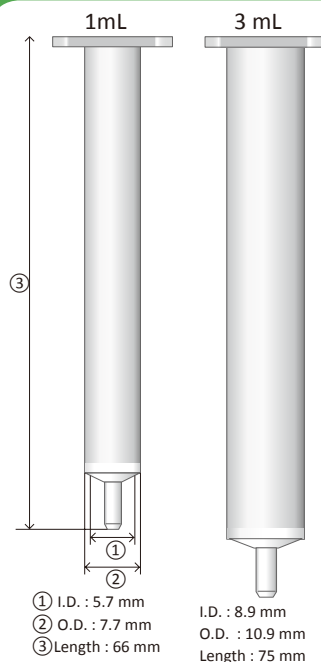
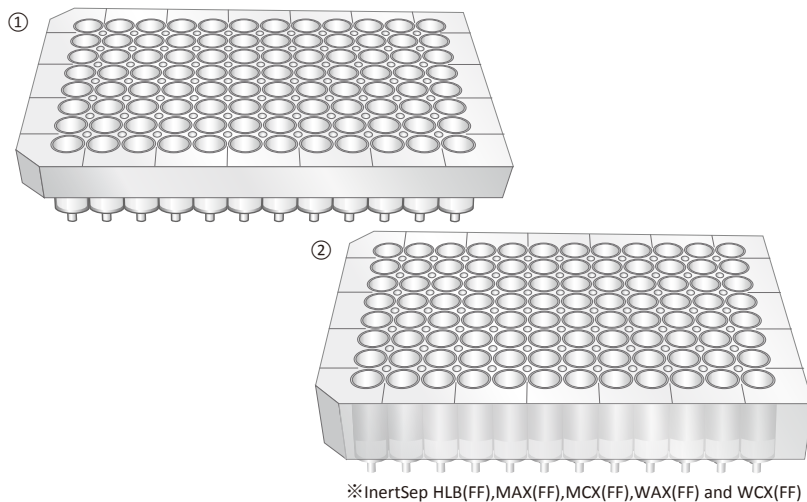

Luer Device Type

Dimensions : Slim: 8.8 ϕ , O.D. length 32 mm, 21 mm
 Slim-J: 8.8 ϕ , O.D. length 51 mm, 31 mm
 mini: 12.7 ϕ , O.D. length 12 mm
 Cartridge material: PP housing and PE frit

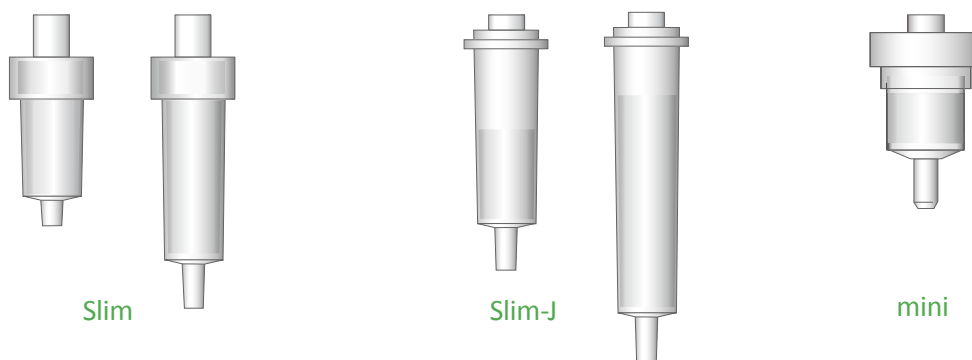

Spin Column Type

Cartridge volume: 1 mL
 Cartridge material: PP housing

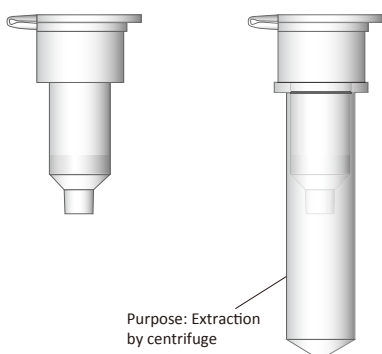

Tip Type

Cartridge volume: 10 μ L, 200 μ L
 Cartridge material: PP housing

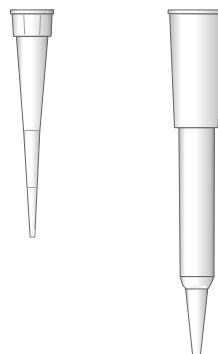

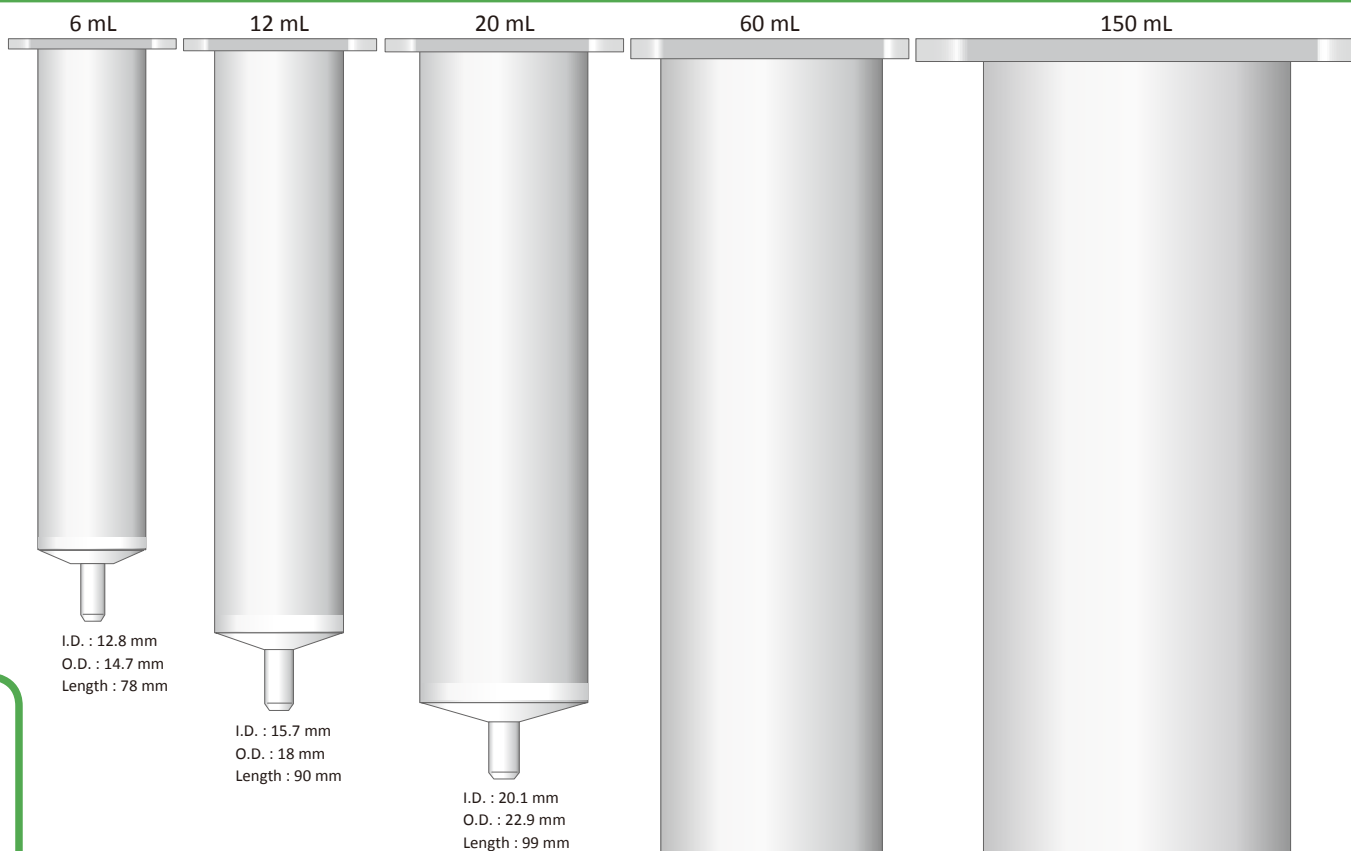

Syringe-Barrel Cartridges (Actual size)

Cartridge volume : 1, 3, 6, 12, 20, 60, 150 mL
Cartridge material : PP housing and PE frit

Large-size Cartridge (LSC)

Cartridge volume : 10 mL
Cartridge material : PP housing and PE frit

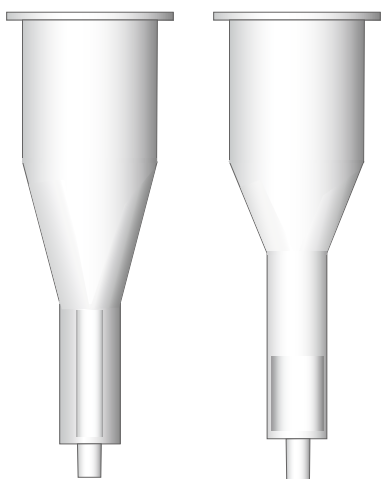

O.D. 6 mm for packed part of small SPE Bulk

O.D. 9 mm for packed part of SPE Bulk

EZ Cartridge

Dimensions : 25 mm
Cartridge material : PP housing

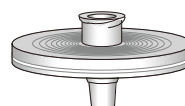

Objective of Solid Phase Extraction (SPE)

Separation and Purification of Target Analytes

The principle of SPE is divided into the following two methods.

① Retaining the target analyte

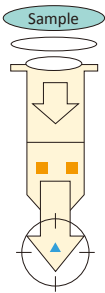

Mainly used to concentrate target analytes in aqueous sample matrix.

② Retaining the sample matrix and letting the target analytes pass through

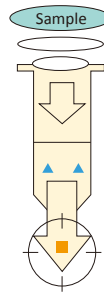

Used in simplification of complex sample matrix such as pesticide residues in crops and organic compounds in soil.

■ Target analyte
▲ Sample matrix

General Four Steps

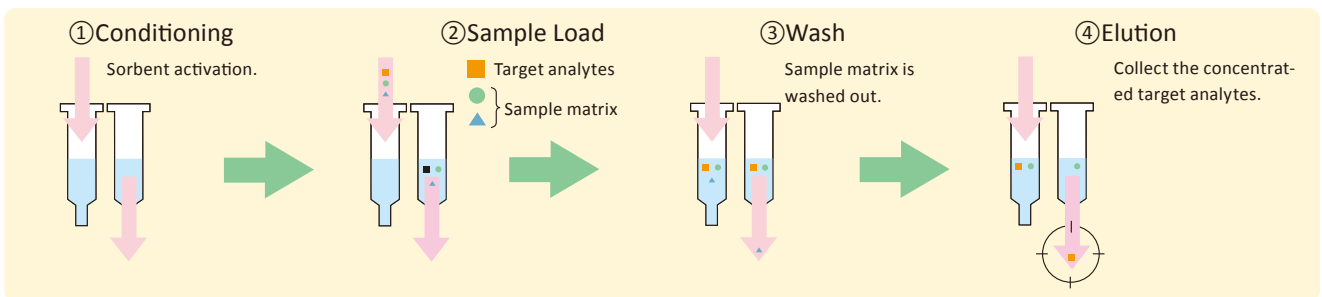

General Methods for Processing Sample

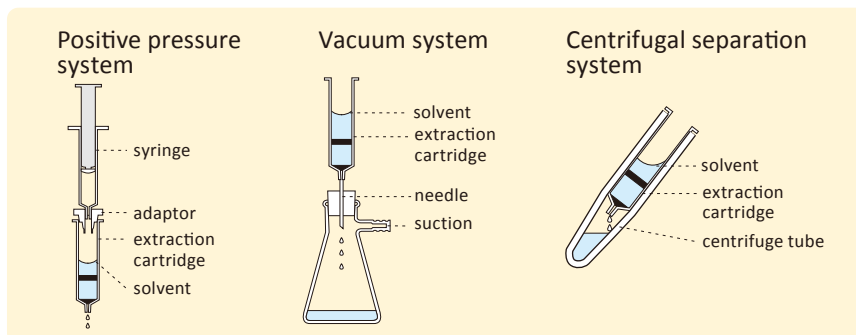

How to Select a Sorbent

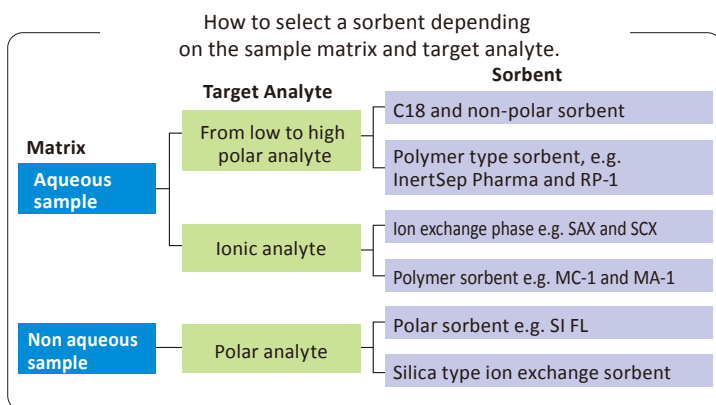

One of the most important elements to achieve successful of solid phase extraction is the selection of a sorbent suitable for both the sample matrix and the target analyte.

The sorbent should be carefully selected by taking into account the chemical and physical properties of both the target analyte and the sample matrix. In addition, it is important to develop conditions that are optimal for retaining the target analyte, while removing the sample matrix, then selecting an elution solvent for maximum recovery of the target analyte.

Retentive Capacity of a Sorbent Compared to Sorbent Mass

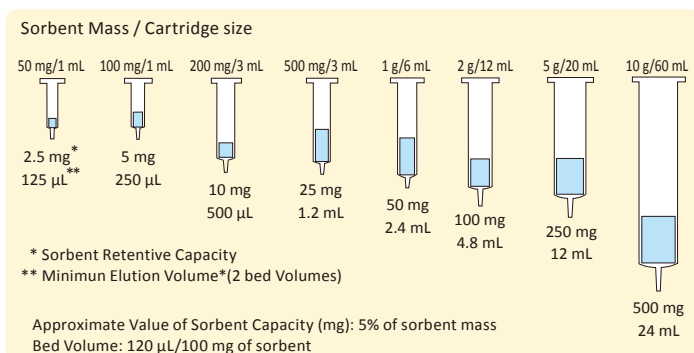

※Bed volume is the quantity of the solvent necessary to replace the air trapped in the solid phase. Void volume is equivalent to the bed volume

Recommendation for Selecting an Ion Exchange Sorbent

| Target Analytes | InertSep | pKa* | Structure | Target Ion | |
|-----------------|-----------------|-----------------------------|--|------------|------------|
| | | | | Weak Ion | Strong Ion |
| Acidic | Anion Exchange | MA-1 4Class Amine | -CH ₂ -N ⁺ (R) ₃ | ✓ | ✗ |
| | | MA-2 2Class Amine | -CH ₂ -N (R) ₂ | ✓ | ✗ |
| | | NH ₂ Aminopropyl | -CH ₂ CH ₂ CH ₂ NH ₂ | ✗ | ✓ |
| | | PSA 1Class, 2Class Amine | -CH ₂ CH ₂ CH ₂ NHCH ₂ CH ₂ NH ₂ | ✗ | ✓ |
| | | SAX Tri-Methylaminopropyl | -CH ₂ CH ₂ CH ₂ N ⁺ (CH ₃) ₃ | ✓ | ✗ |
| | | SAX-2 | -CH ₂ CH ₂ CH ₂ N ⁺ (CH ₃) ₃ | ✓ | ✗ |
| Basic | Cation Exchange | MC-1 Sulfonic Acid | -CH ₂ -SO ₃ ⁻ | ✓ | ✗ |
| | | MC-2 Carboxylic Acid | -CH ₂ -COO ⁻ | ✓ | ✗ |
| | | CBA Ethyl Carboxylic Acid | -CH ₂ CH ₂ COO ⁻ | ✗ | ✓ |
| | | PRS Propyl Sulfonic Acid | -CH ₂ CH ₂ CH ₂ SO ₃ ⁻ | ✓ | ✗ |
| | | SCX Benzene Sulfonic Acid | -CH ₂ CH ₂ C ₆ H ₄ SO ₃ ⁻ | ✓ | ✗ |
| | | SCX-2 | -CH ₂ CH ₂ C ₆ H ₄ SO ₃ ⁻ | ✓ | ✗ |

* pKa reference value for each functional group.

InertSep Sorbent Specifications

| | InertSep | Page | Base Gel | Functional group | End-Capping |
|------------------------------------|----------------------|----------------------------------|--|-------------------------------------|-------------|
| Polymer-Based SPE (Reversed Phase) | HLB | 12 | N-MA-SDB | - | - |
| | HLB FF | 12 | | - | - |
| | PLS-2 | 13 | SDB | - | - |
| | PLS-3 | 13 | N-MA-SDB | - | - |
| | EZ Cartridge RP-1 | 14 | MA-DVB | - | - |
| | Pharma | 15 | N-MA-SDB | - | - |
| Pharma FF | 15 | - | | - | |
| Polymer-Based SPE (Ion Exchange) | MA-1 | 16 | MA | Quaternary ammonium | - |
| | MA-2 | 17 | | Diethyl amine | - |
| | MC-1 | 18 | | Sulfonic acid | - |
| | MC-2 | 19 | | Carboxylic acid | - |
| | MAX | 20 | SDB | Quaternary ammonium | - |
| | MAX FF | 20 | | Quaternary ammonium | - |
| | WAX | 22 | | Diethyl amine | - |
| | WAX FF | 22 | | Diethyl amine | - |
| | MCX | 21 | | Sulfonic acid | - |
| | MCX FF | 21 | | Sulfonic acid | - |
| | WCX | 23 | | Carboxylic acid | - |
| | WCX FF | 23 | | Carboxylic acid | - |
| Polymer-Based SPE (Chelate) | ME-1 | 24 | MA | Iminodiacetic acid | - |
| | ME-2 | 25 | | Iminodiacetic acid + Tertiary amine | - |
| Silica-Based SPE (Non-Polar) | C18 | 26 | SiO ₂ | Octadecyl (trifunctional) | High |
| | C18 FF | 27 | | Octadecyl (trifunctional) | High |
| | C18-B | 28 | | Octadecyl (monofunctional) | Middle |
| | C18-C | 29 | | Octadecyl (trifunctional) | Low |
| | C18-C FF | 30 | | Octadecyl (trifunctional) | Low |
| | C18-ENV | 31 | | Octadecyl (trifunctional) | Low |
| | C8 | 32 | | Octyl | Middle |
| | C2 | 33 | | Ethyl | Middle |
| | CH | 34 | | Cyclohexyl | Middle |
| | PH | 35 | | Phenyl | Middle |
| Silica-Based SPE (Polar) | CN | 36 | Aluminium oxide | Cyanopropyl | - |
| | ZOH | 37 | | Diol | - |
| | SI | 38 | | - | - |
| | SI FF | 39 | | - | - |
| | AL-A | 40 | | - | - |
| | AL-N | 41 | | - | - |
| | AL-B | 42 | | - | - |
| | FL | 43 | | Magnesium silicate (Florisil) | - |
| FL-PR | 44 | Magnesium silicate (Florisil PR) | - | | |
| Silica-Based SPE (Ion Exchange) | CBA | 45 | SiO ₂ | Propylcarboxylic acid | - |
| | PRS | 46 | | Propylsulfonic acid | - |
| | SCX | 47 | | Benzenesulfonic acid | - |
| | SCX-2 | 48 | | Benzenesulfonic acid | - |
| | NH2 | 49 | | AminoPropyl | - |
| | NH2 FF | 50 | | AminoPropyl | - |
| | PSA | 51 | | Ethylenediamine-N-propyl | - |
| | SAX | 52 | | Quaternary ammonium | - |
| SAX-2 | 53 | Quaternary ammonium | - | | |
| Specialty Phases SPE | AC | 54 | Activated Carbon | - | - |
| | GC | 54 | Graphite Carbon | - | - |
| | DRY | 57 | Sodium sulfate, anhydrous (Na ₂ SO ₄) | - | - |
| | K-solute | 58 | Diatomaceous earth | - | - |
| | Phospholipid Remover | 58 | - | - | - |

MA : Methacrylate polymer SDB : Styrene-Divinylbenzene copolymer DVB : Divinylbenzene copolymer

| Average Particle Size (µm) | Surface Area (m ² /g) | Pore Size (nm) | Pore Volume (mL/g) | Carbon Load (%) | Ion exchange capacity (meq/g) | pH Range | Remark |
|----------------------------|----------------------------------|----------------|--------------------|-----------------|-------------------------------|----------|----------------------------------|
| 30 | 720 | 7 | 1.3 | - | - | 1-14 | |
| 60 | 720 | 7 | 1.3 | - | - | 1-14 | |
| 70 | 700 | 7 | 1.1 | - | - | 1-14 | |
| 60 | 600 | 7 | 1.1 | - | - | 1-14 | |
| 10 | - | - | - | - | - | 1-14 | |
| 30 | 600 | 7 | 1.1 | - | - | 1-14 | |
| 60 | 600 | 7 | 1.1 | - | - | 1-14 | |
| 70 | 250 | 13 | 0.7 | - | 0.5 | 1-14 | Cl ⁻ ion pair |
| 70 | 250 | 13 | 0.8 | - | 0.5 | 1-14 | Cl ⁻ ion pair |
| 70 | 80 | 20 | 0.4 | - | 0.5 | 1-14 | Na ⁺ ion pair |
| 70 | 80 | 18 | 0.4 | - | 0.5 | 1-14 | Na ⁺ ion pair |
| 30 | 520 | 9 | 1.2 | - | 0.3 | 1-14 | Cl ⁻ ion pair |
| 70 | 480 | 9 | 1.1 | - | 0.3 | 1-14 | Cl ⁻ ion pair |
| 30 | 520 | 9 | 1.2 | - | 0.5 | 1-14 | OH ⁻ ion pair |
| 70 | 480 | 9 | 1.1 | - | 0.7 | 1-14 | OH ⁻ ion pair |
| 30 | 520 | 9 | 1.2 | - | 1.3 | 1-14 | H ⁺ ion pair |
| 70 | 480 | 9 | 1.1 | - | 1.2 | 1-14 | H ⁺ ion pair |
| 30 | 520 | 9 | 1.2 | - | 1.5 | 1-14 | H ⁺ ion pair |
| 70 | 480 | 9 | 1.1 | - | 1.2 | 1-14 | H ⁺ ion pair |
| 70 | 80 | 21 | 0.5 | - | Cu ²⁺ 0.3 (mmol/g) | 1-14 | H ⁺ ion pair |
| 70 | 80 | 21 | 0.5 | - | Cu ²⁺ 0.3 (mmol/g) | 1-14 | H ⁺ ion pair |
| 60 | 450 | 6 | 0.7 | 19 | - | 2-8 | High Inertness |
| 120 | 450 | 6 | 0.7 | 19 | - | 2-8 | High Inertness |
| 45 | 450 | 6 | 0.7 | 14 | - | 2-8 | Normal Inertness |
| 60 | 450 | 6 | 0.7 | 16 | - | 2-8 | Poor Inertness |
| 120 | 450 | 6 | 0.7 | 16 | - | 2-8 | Poor Inertness |
| 60 | 450 | 6 | 0.7 | 16 | - | 2-8 | |
| 60 | 450 | 6 | 0.7 | 12 | - | 2-8 | |
| 60 | 450 | 6 | 0.7 | 5.5 | - | 2-8 | |
| 60 | 450 | 6 | 0.7 | 7.5 | - | 2-8 | |
| 60 | 450 | 6 | 0.7 | 10 | - | 2-8 | |
| 45 | 450 | 6 | 0.7 | 7.5 | - | 2-8 | |
| 60 | 450 | 6 | 0.7 | 10 | - | 2-8 | |
| 60 | 450 | 6 | 0.7 | - | - | 2-8 | |
| 120 | 450 | 6 | 0.7 | - | - | 2-8 | |
| 100 | 130 | 8 | 0.3 | - | - | - | acid(pH3.5-5.0) |
| 100 | 130 | 8 | 0.3 | - | - | - | neutral(pH6.0-7.5) |
| 100 | 130 | 8 | 0.3 | - | - | - | basic(pH9.0-10.5) |
| 50-200 | 230 | 9 | 0.5 | - | - | - | |
| 100-300 | 230 | 9 | 0.5 | - | - | - | |
| 45 | 450 | 6 | 0.7 | 8.5 | 1.2 | 2-8 | H ⁺ ion pair |
| 45 | 450 | 6 | 0.7 | 8.5 | 1.2 | 2-8 | H ⁺ ion pair |
| 45 | 450 | 6 | 0.7 | 8.5 | 0.6 | 2-8 | H ⁺ ion pair |
| 60 | 450 | 6 | 0.7 | 17 | 1.2 | 2-8 | Na ⁺ ion pair |
| 60 | 450 | 6 | 0.7 | 10 | 0.9 | 2-8 | |
| 120 | 450 | 6 | 0.7 | 10 | 0.9 | 2-8 | |
| 60 | 450 | 6 | 0.7 | 11.5 | 1.5 | 2-8 | |
| 45 | 450 | 6 | 0.7 | 7 | 0.7 | 2-8 | OH ⁻ ion pair |
| 60 | 450 | 6 | 0.7 | 11.5 | 0.45 | 2-8 | Cl ⁻ ion pair |
| 60/150(mesh) | 800-1200 | - | - | - | - | - | |
| 120/400(mesh) | 85 | 45 | 1 | - | - | - | |
| - | - | - | - | - | - | - | |
| 10/42mesh > 90 % | - | - | - | - | - | - | |
| - | - | - | - | - | - | - | Phospholipid removal ratio > 90% |



1. InertSep Series

| | |
|--|----|
| ● Polymer-Based SPE (Reversed Phase) | 12 |
| ● Polymer-Based SPE (Ion Exchange) | 16 |
| ● Polymer-Based SPE (Chelate) | 24 |
| ● Silica-Based SPE (Non-Polar) | 26 |
| ● Silica-Based SPE (Polar) | 36 |
| ● Silica-Based SPE (Ion Exchange) | 45 |
| ● Specialty SPE | 54 |

Polymer-Based SPE (Reversed Phase)

1

InertSep Series

InertSep HLB

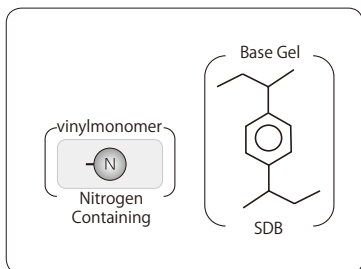

Average Particle Size : 30 μm
 Surface Area : 720 m^2/g
 Pore Volume : 1.3 mL/g
 Pore Size : 7 nm
 pH Range : 1-14

InertSep HLB is a reversed phase sorbent made of styrene-divinylbenzene (SDB) and a nitrogen-containing vinyl monomer.

Syringe-Barrel Cartridges

| Description | Bed Weight/Volume | Qty. | Cat.No. |
|--------------|-------------------|---------|------------|
| InertSep HLB | 10 mg/1 mL | 100 pcs | 5010-27520 |
| | 30 mg/1 mL | 100 pcs | 5010-27521 |
| | 60 mg/3 mL | 50 pcs | 5010-27522 |
| | 150 mg/6 mL | 30 pcs | 5010-27525 |
| | 200 mg/6 mL | 30 pcs | 5010-27523 |
| | 500 mg/6 mL | 30 pcs | 5010-27524 |

Large-Size Cartridges(LSC)

| Description | Bed Weight/Volume | Qty. | Cat.No. |
|------------------|-------------------|--------|------------|
| InertSep LSC HLB | 30 mg | 50 pcs | 5010-27625 |
| | 60 mg | 50 pcs | 5010-27626 |

96 Well Plate

| Description | Bed Weight/Volume | Qty. | Cat.No. |
|-------------------|-------------------|------|------------|
| InertSep 96WP HLB | 5 mg | 1 pc | 5010-66442 |
| | 10 mg | 1 pc | 5010-66440 |
| | 30 mg | 1 pc | 5010-66441 |

Bulk Material

| Description | Volume | Cat.No. |
|--------------|--------|------------|
| InertSep HLB | 10 g | 5010-69130 |
| | 100 g | 5010-69131 |

InertSep HLB FF

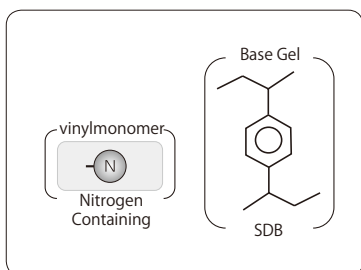

Average Particle Size : 60 μm
 Surface Area : 720 m^2/g
 Pore Volume : 1.3 mL/g
 Pore Size : 7 nm
 pH Range : 1-14

InertSep HLB FF is a high-flow version of InertSep HLB. Effective for rapid processing of highly viscous samples.

Syringe-Barrel Cartridges

| Description | Bed Weight/Volume | Qty. | Cat.No. |
|-----------------|-------------------|---------|------------|
| InertSep HLB FF | 60 mg/3 mL | 50 pcs | 5010-27532 |
| | 150 mg/6 mL | 30 pcs | 5010-27539 |
| | 200 mg/6 mL | 30 pcs | 5010-27533 |
| | 200 mg/20 mL | 20 pcs | 5010-27535 |
| | 400 mg/3 mL | 100 pcs | 5010-27537 |
| | 500 mg/6 mL | 30 pcs | 5010-27534 |
| | 500 mg/12 mL | 20 pcs | 5010-27540 |
| | 500 mg/20 mL | 20 pcs | 5010-27536 |
| | 540 mg/3 mL | 100 pcs | 5010-27538 |
| | 1 g/20 mL | 20 pcs | 5010-27541 |

96-Well Plates

| Description | Bed Weight/Volume | Qty. | Cat.No. |
|----------------------|-------------------|------|------------|
| InertSep 96WP HLB FF | 60 mg | 1 pc | 5010-66450 |

Luer-Device Cartridges

| Description | Bed Weight/Volume | Qty. | Cat.No. |
|------------------------|-------------------|--------|------------|
| InertSep Slim-J HLB FF | 225 mg | 50 pcs | 5010-65795 |

Bulk Material

| Description | Volume | Cat.No. |
|-----------------|--------|------------|
| InertSep HLB FF | 10 g | 5010-69132 |
| | 100 g | 5010-69133 |

Polymer-Based SPE (Reversed Phase)

1

InertSep Series

InertSep PLS-2

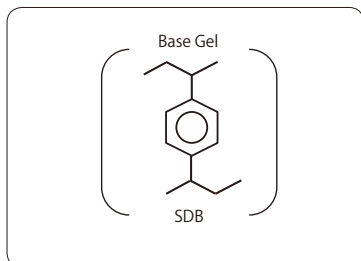

Average Particle Size : 70 µm
 Surface Area : 700 m²/g
 Pore Volume : 1.1 mL/g
 Pore Size : 7 nm
 pH Range : 1-14

InertSep PLS-2 is a SDB polymer-based reversed phase sorbent. Compared to silica based C18 sorbents, InertSep PLS-2 has a quite higher retention capacity and better stability in a wide pH range.

Syringe-Barrel Cartridges

| Description | Bed Weight/Volume | Qty.(pk unit) | Cat.No. |
|----------------|-------------------|----------------|------------|
| InertSep PLS-2 | 265 mg/6 mL | 50 pcs(25 pcs) | 5010-27430 |
| | 265 mg/20 mL | 20 pcs(10 pcs) | 5010-27431 |
| | 270 mg/6 mL | 50 pcs(5 pcs) | 5010-25020 |
| | 500 mg/6 mL | 30 pcs | 5010-25025 |
| | 1 g/6 mL | 20 pcs(5 pcs) | 5010-25030 |
| | 270 mg/20 mL | 20 pcs | 5010-25035 |
| | 500 mg/20 mL | 20 pcs(10 pcs) | 5010-25036 |

Luer-Device Cartridges

| Description | Bed Weight/Volume | Qty. | Cat.No. |
|---------------------------------|-------------------|--------|------------|
| InertSep Slim-J PLS-2 | 230 mg | 50 pcs | 5010-65720 |
| | 265 mg | 50 pcs | 5010-65721 |
| InertSep Slim-J PLS-2 for AQUA* | 265 mg | 50 pcs | 5010-65726 |

* InertSep PLS-2 was developed for water quality and environmental analysis.

Bulk Material

| Description | Volume | Cat.No. |
|----------------|--------|------------|
| InertSep PLS-2 | 10 g | 5010-69100 |
| | 100 g | 5010-69101 |

InertSep PLS-3

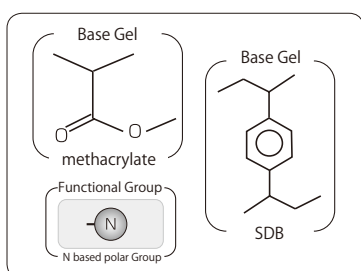

Average Particle Size : 60 µm
 Surface Area : 600 m²/g
 Pore Volume : 1.1 mL/g
 Pore Size : 7 nm
 pH Range : 1-14

InertSep PLS-3 is a copolymer-based sorbent comprised of nitrogen-containing methacrylate and SDB, exhibiting adequate retention for a variety of compounds from highly polar to hydrophobic compounds.

Syringe-Barrel Cartridges

| Description | Bed Weight/Volume | Qty.(pk unit) | Cat.No. |
|----------------------|-------------------|----------------|------------|
| InertSep PLS-3 | 200 mg/6 mL | 30 pcs | 5010-25050 |
| | 200 mg/20 mL | 20 pcs(10 pcs) | 5010-25051 |
| InertSep Glass PLS-3 | 200 mg/6 mL | 20 pcs | 5010-26020 |

Luer-Device Cartridges

| Description | Bed Weight/Volume | Qty.(pk unit) | Cat.No. |
|---------------------------------|-------------------|-----------------|------------|
| InertSep Slim-J PLS-3 | 230 mg | 50 pcs | 5010-25200 |
| | | 500 pcs(50 pcs) | 5010-25205 |
| InertSep Slim-J PLS-3 for AQUA* | 230 mg | 50 pcs | 5010-65775 |

* InertSep PLS-3 was developed for water quality and environmental analysis.

Bulk Material

| Description | Volume | Cat.No. |
|----------------|--------|------------|
| InertSep PLS-3 | 10 g | 5010-69102 |
| | 100 g | 5010-69103 |

Polymer-Based SPE (Reversed Phase)

EZ Cartridge RP-1



EZ Cartridge RP-1 is a new type of cartridge that incorporates a 25 mm disc for use with pressurized pumping systems.

| Description | Qty. | Cat.No. |
|-------------------|--------|------------|
| EZ Cartridge RP-1 | 50 pcs | 5010-30250 |

1

InertSep Series

Polymer-Based SPE (Reversed Phase)

InertSep Pharma

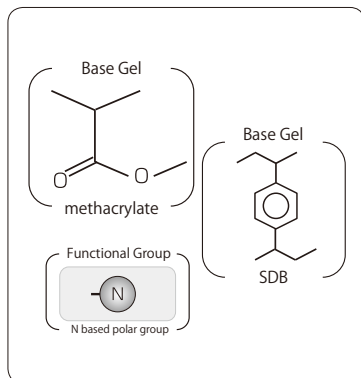

Average Particle Size : 30 μm
 Surface Area : 600 m^2/g
 Pore Volume : 1.1 mL/g
 Pore Size : 7 nm
 pH Range : 1-14

InertSep Pharma is a copolymer-based sorbent comprised of nitrogen-containing methacrylate and SDB. This sorbent was developed for simultaneous screening of drug metabolites in biological samples.

Syringe-Barrel Cartridges

| Description | Bed Weight/Volume | Qty. | Cat.No. |
|-----------------|-------------------|---------|------------|
| InertSep Pharma | 10 mg/1 mL | 100 pcs | 5010-27102 |
| | 30 mg/1 mL | 100 pcs | 5010-27100 |
| | 60 mg/3 mL | 100 pcs | 5010-27101 |
| | 200 mg/6 mL | 30 pcs | 5010-27103 |
| | 500 mg/6 mL | 30 pcs | 5010-27104 |
| | 500 mg/12 mL | 20 pcs | 5010-27105 |

Large-Size Cartridges (LSC)

| Description | Bed Weight/Volume | Qty.(pk unit) | Cat.No. |
|---------------------|-------------------|----------------|------------|
| InertSep LSC Pharma | 30 mg | 50 pcs(25 pcs) | 5010-27621 |
| | 60 mg | 50 pcs(25 pcs) | 5010-27622 |
| | 200 mg | 50 pcs(25 pcs) | 5010-27623 |
| | 500 mg | 50 pcs(25 pcs) | 5010-27624 |

96-Well Plates

| Description | Bed Weight/Volume | Qty. | Cat.No. |
|----------------------|-------------------|------|------------|
| InertSep 96WP Pharma | 30 mg | 1 pc | 5010-66230 |
| | 60 mg | 1 pc | 5010-66231 |

Bulk Material

| Description | Volume | Cat.No. |
|-----------------|--------|------------|
| InertSep Pharma | 10 g | 5010-69112 |
| | 100 g | 5010-69113 |

InertSep Pharma FF

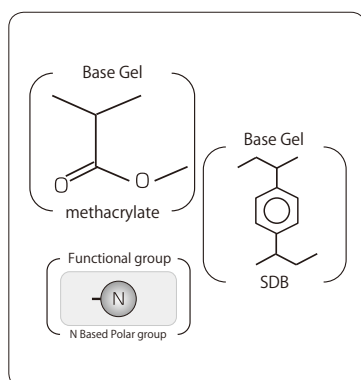

Average Particle Size : 60 μm
 Surface Area : 600 m^2/g
 Pore Volume : 1.1 mL/g
 Pore Size : 7 nm
 pH Range : 1-14

InertSep Pharma FF is a modified version of InertSep Pharma for high flow lates. This sorbent is suitable for viscous biological samples and large volume samples.

Syringe-Barrel Cartridges

| Description | Bed Weight/Volume | Qty. | Cat.No. |
|--------------------|-------------------|---------|------------|
| InertSep Pharma FF | 60 mg/3 mL | 100 pcs | 5010-27111 |
| | 200 mg/6 mL | 30 pcs | 5010-27113 |
| | 500 mg/6 mL | 30 pcs | 5010-27114 |

Large-Size Cartridges(LSC)

| Description | Bed Weight/Volume | Qty. | Cat.No. |
|------------------------|-------------------|---------|------------|
| InertSep LSC Pharma FF | 10 mg | 500 pcs | 5010-27620 |

Luer-Device Cartridges

| Description | Bed Weight/Volume | Qty. | Cat.No. |
|---------------------------|-------------------|--------|------------|
| InertSep Slim-J Pharma FF | 230 mg | 50 pcs | 5010-65740 |

Bulk Material

| Description | Volume | Cat.No. |
|--------------------|--------|------------|
| InertSep Pharma FF | 10 g | 5010-69114 |
| | 100 g | 5010-69115 |

Polymer-Based SPE (Ion Exchange)

1

InertSep Series

InertSep MA-1

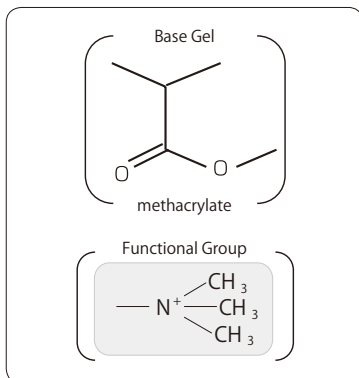

Average Particle Size : 70 μm
 Surface Area : 250 m^2/g
 Pore Volume : 0.7 mL/g
 Pore Size : 13 nm
 Ion exchange capacity : 0.5 meq/g
 pH Range : 1-14
 Remark : Cl^- ion pair

InertSep MA-1 is a methacrylate polymer-based sorbent modified with strong anion exchange functional groups. This sorbent is highly hydrophilic, and retained anions can be easily eluted.

Syringe-Barrel Cartridges

| Description | Bed Weight/Volume | Qty.(pk unit) | Cat.No. |
|---------------|-------------------|-----------------|------------|
| InertSep MA-1 | 10 mg/1 mL | 100 pcs | 5010-27303 |
| | 30 mg/1 mL | 100 pcs(50 pcs) | 5010-27304 |
| | 60 mg/3 mL | 100 pcs(50 pcs) | 5010-27305 |
| | 100 mg/3 mL | 50 pcs(25 pcs) | 5010-27300 |
| | 250 mg/6 mL | 30 pcs | 5010-27301 |
| | 500 mg/6 mL | 30 pcs | 5010-27302 |
| | 1 g/20 mL | 20 pcs(10 pcs) | 5010-27306 |
| | 2 g/20 mL | 20 pcs(10 pcs) | 5010-27307 |

Large-Size Cartridges (LSC)

| Description | Bed Weight/Volume | Qty.(pk unit) | Cat.No. |
|-------------------|-------------------|----------------|------------|
| InertSep LSC MA-1 | 10 mg | 50 pcs(25 pcs) | 5010-27630 |
| | 30 mg | 50 pcs(25 pcs) | 5010-27631 |
| | 60 mg | 50 pcs(25 pcs) | 5010-27632 |
| | 200 mg | 50 pcs(25 pcs) | 5010-27633 |
| | 500 mg | 50 pcs(25 pcs) | 5010-27634 |

Luer-Device Cartridges

| Description | Bed Weight/Volume | Qty. | Cat.No. |
|--------------------|-------------------|--------|------------|
| InertSep mini MA-1 | 280 mg | 50 pcs | 5010-27205 |

96-Well Plates

| Description | Bed Weight/Volume | Qty. | Cat.No. |
|--------------------|-------------------|------|------------|
| InertSep 96WP MA-1 | 30 mg | 1 pc | 5010-66700 |
| | 60 mg | 1 pc | 5010-66701 |

Bulk Material

| Description | Volume | Cat.No. |
|---------------|--------|------------|
| InertSep MA-1 | 10 g | 5010-69116 |
| | 100 g | 5010-69117 |

Polymer-Based SPE (Ion Exchange)

InertSep MA-2

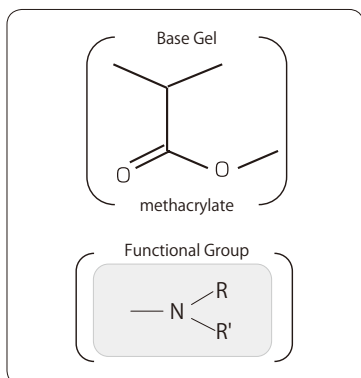

| | |
|-----------------------|-----------------------------|
| Average Particle Size | : 70 μm |
| Surface Area | : 250 m^2/g |
| Pore Volume | : 0.8 mL/g |
| Pore Size | : 13 nm |
| Ion exchange capacity | : 0.8 meq/g |
| pH Range | : 1-14 |
| Remark | : Cl^- ion pair |

InertSep MA-2 is a methacrylate polymer based sorbent modified with weak anion exchange groups. Suppressed secondary interactions of methacrylate polymer gel enables SPE solely by ion exchange.

Syringe-Barrel Cartridges

| Description | Bed Weight/Volume | Qty.(pk unit) | Cat.No. |
|---------------|-------------------|-----------------|------------|
| InertSep MA-2 | 10 mg/1 mL | 100 pcs(50 pcs) | 5010-27323 |
| | 30 mg/1 mL | 100 pcs(50 pcs) | 5010-27324 |
| | 60 mg/3 mL | 100 pcs(50 pcs) | 5010-27325 |
| | 100 mg/3 mL | 50 pcs(25 pcs) | 5010-27320 |
| | 150 mg/3 mL | 50 pcs(25 pcs) | 5010-27319 |
| | 150 mg/6 mL | 50 pcs | 5010-27331 |
| | 200 mg/6 mL | 30 pcs | 5010-27330 |
| | 250 mg/6 mL | 30 pcs | 5010-27321 |
| | 500 mg/6 mL | 30 pcs | 5010-27322 |
| | 1 g/20 mL | 20 pcs(10 pcs) | 5010-27326 |
| 2 g/20 mL | 20 pcs(10 pcs) | 5010-27327 | |

Large-Size Cartridges (LSC)

| Description | Bed Weight/Volume | Qty.(pk unit) | Cat.No. |
|-------------------|-------------------|----------------|------------|
| InertSep LSC MA-2 | 10 mg | 50 pcs(25 pcs) | 5010-27640 |
| | 30 mg | 50 pcs(25 pcs) | 5010-27641 |
| | 60 mg | 50 pcs(25 pcs) | 5010-27642 |
| | 150 mg | 50 pcs(25 pcs) | 5010-27645 |
| | 200 mg | 50 pcs(25 pcs) | 5010-27643 |
| | 500 mg | 50 pcs(25 pcs) | 5010-27644 |

Luer-Device Cartridges

| Description | Bed Weight/Volume | Qty. | Cat.No. |
|--------------------|-------------------|--------|------------|
| InertSep mini MA-2 | 280 mg | 50 pcs | 5010-27235 |

96-Well Plates

| Description | Bed Weight/Volume | Qty. | Cat.No. |
|--------------------|-------------------|------|------------|
| InertSep 96WP MA-2 | 30 mg | 1 pc | 5010-66710 |
| | 60 mg | 1 pc | 5010-66711 |

Bulk Material

| Description | Volume | Cat.No. |
|---------------|--------|------------|
| InertSep MA-2 | 10 g | 5010-69118 |
| | 100 g | 5010-69119 |

Polymer-Based SPE (Ion Exchange)

1

InertSep Series

InertSep MC-1

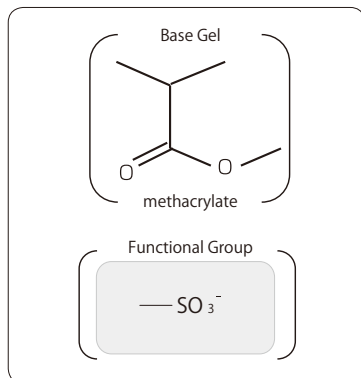

Average Particle Size : 70 μm
 Surface Area : 80 m²/g
 Pore Volume : 0.4 mL/g
 Pore Size : 20 nm
 Ion exchange capacity : 0.5 meq/g
 pH Range : 1-14
 Remark : Na⁺ ion pair

InertSep MC-1 is a methacrylate polymer based sorbent modified with strong cation exchange functional groups. This sorbent is highly hydrophilic, and retained cations can be easily eluted.

Syringe-Barrel Cartridges

| Description | Bed Weight/Volume | Qty.(pk unit) | Cat.No. |
|---------------|-------------------|-----------------|------------|
| InertSep MC-1 | 10 mg/1 mL | 100 pcs(50 pcs) | 5010-27353 |
| | 30 mg/1 mL | 100 pcs(50 pcs) | 5010-27354 |
| | 60 mg/3 mL | 100 pcs(50 pcs) | 5010-27355 |
| | 100 mg/3 mL | 50 pcs(25 pcs) | 5010-27350 |
| | 250 mg/6 mL | 30 pcs | 5010-27351 |
| | 500 mg/6 mL | 30 pcs | 5010-27352 |
| | 1 g/20 mL | 20 pcs(10 pcs) | 5010-27356 |
| | 2 g/20 mL | 20 pcs(10 pcs) | 5010-27357 |

Large-Size Cartridges (LSC)

| Description | Bed Weight/Volume | Qty.(pk unit) | Cat.No. |
|-------------------|-------------------|----------------|------------|
| InertSep LSC MC-1 | 10 mg | 50 pcs(25 pcs) | 5010-27650 |
| | 30 mg | 50 pcs(25 pcs) | 5010-27651 |
| | 60 mg | 50 pcs(25 pcs) | 5010-27652 |
| | 200 mg | 50 pcs(25 pcs) | 5010-27653 |
| | 500 mg | 50 pcs(25 pcs) | 5010-27654 |

Luer-Device Cartridges

| Description | Bed Weight/Volume | Qty. | Cat.No. |
|--------------------|-------------------|--------|------------|
| InertSep mini MC-1 | 280 mg | 50 pcs | 5010-27210 |

96-Well Plates

| Description | Bed Weight/Volume | Qty. | Cat.No. |
|--------------------|-------------------|------|------------|
| InertSep 96WP MC-1 | 30 mg | 1 pc | 5010-66500 |
| | 60 mg | 1 pc | 5010-66501 |

Bulk Material

| Description | Volume | Cat.No. |
|---------------|--------|------------|
| InertSep MC-1 | 10 g | 5010-69120 |
| | 100 g | 5010-69121 |

Polymer-Based SPE (Ion Exchange)

InertSep MC-2

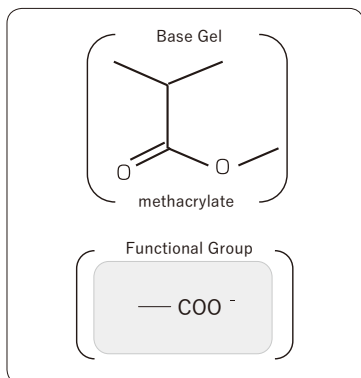

Average Particle Size : 70 μm
 Surface Area : 80 m²/g
 Pore Volume : 0.4 mL/g
 Pore Size : 18 nm
 Ion exchange capacity : 0.5 meq/g
 pH Range : 1-14
 Remark : Na⁺ ion pair

InertSep MC-2 is a methacrylate polymer based sorbent modified with weak cation exchange functional groups. This sorbent is suitable for SPE of strong anion compounds in ion exchange mode. Suppressed secondary interactions of methacrylate polymer gel enables SPE solely by ion exchange.

Syringe-Barrel Cartridges

| Description | Bed Weight/Volume | Qty.(pk unit) | Cat.No. |
|---------------|-------------------|-----------------|------------|
| InertSep MC-2 | 10 mg/1 mL | 100 pcs(50 pcs) | 5010-27373 |
| | 30 mg/1 mL | 100 pcs(50 pcs) | 5010-27374 |
| | 60 mg/3 mL | 100 pcs(50 pcs) | 5010-27375 |
| | 100 mg/3 mL | 50 pcs(25 pcs) | 5010-27370 |
| | 250 mg/6 mL | 30 pcs | 5010-27371 |
| | 500 mg/6 mL | 30 pcs | 5010-27372 |
| | 1 g/20 mL | 20 pcs(10 pcs) | 5010-27376 |
| | 2 g/20 mL | 20 pcs(10 pcs) | 5010-27377 |

Large-Size Cartridges (LSC)

| Description | Bed Weight/Volume | Qty.(pk unit) | Cat.No. |
|-------------------|-------------------|----------------|------------|
| InertSep LSC MC-2 | 10 mg | 50 pcs(25 pcs) | 5010-27660 |
| | 30 mg | 50 pcs(25 pcs) | 5010-27661 |
| | 60 mg | 50 pcs(25 pcs) | 5010-27662 |
| | 200 mg | 50 pcs(25 pcs) | 5010-27663 |
| | 500 mg | 50 pcs(25 pcs) | 5010-27664 |

Luer-Device Cartridges

| Description | Bed Weight/Volume | Qty. | Cat.No. |
|--------------------|-------------------|--------|------------|
| InertSep mini MC-2 | 280 mg | 50 pcs | 5010-27240 |

96-Well Plates

| Description | Bed Weight/Volume | Qty. | Cat.No. |
|--------------------|-------------------|------|------------|
| InertSep 96WP MC-2 | 30 mg | 1 pc | 5010-66510 |
| | 60 mg | 1 pc | 5010-66511 |

Bulk Material

| Description | Volume | Cat.No. |
|---------------|--------|------------|
| InertSep MC-2 | 10 g | 5010-69122 |
| | 100 g | 5010-69123 |

Polymer-Based SPE (Ion Exchange)

1

InertSep Series

InertSep MAX Hydrophobic polymer modified by a strong anion-exchange groupe

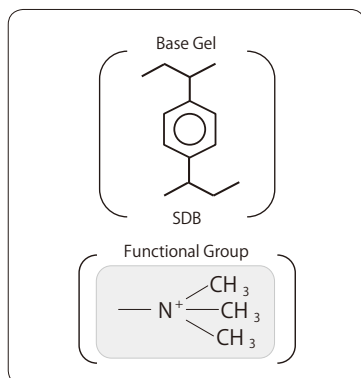

Average Particle Size : 30 μm
 Surface Area : 520 m^2/g
 Pore Volume : 1.2 mL/g
 Pore diameter : 9 nm
 pH Range : 1-14
 Ion exchange capacity : 0.3 meq/g

InertSep MAX is a mixed-mode SPE sorbent based on styrene divinylbenzene polymer modified by a strong anion-exchange group. It has a hydrophobic and an anion-exchange interaction, making it suitable for the pretreatment of weak acidic compounds.

Syringe-Barrel Cartridges

| Description | Bed Weight/Volume | Qty. | Cat.No. |
|--------------|-------------------|---------|------------|
| InertSep MAX | 10 mg/1 mL | 100 pcs | 5010-62730 |
| | 30 mg/1 mL | 100 pcs | 5010-62731 |
| | 60 mg/3 mL | 50 pcs | 5010-62732 |
| | 150 mg/6 mL | 30 pcs | 5010-62733 |

Large-Size Cartridges(LSC)

| Description | Bed Weight/Volume | Qty. | Cat.No. |
|------------------|-------------------|--------|------------|
| InertSep LSC MAX | 30 mg | 50 pcs | 5010-27565 |
| | 60 mg | 50 pcs | 5010-27566 |

96 Well Plates

| Description | Bed Weight/Volume | Qty. | Cat.No. |
|-------------------|-------------------|------|------------|
| InertSep 96WP MAX | 10 mg | 1 pc | 5010-66480 |
| | 30 mg | 1 pc | 5010-66481 |
| | 60 mg | 1 pc | 5010-66482 |

InertSep MAX FF Hydrophobic polymer modified by a strong anion-exchange groupe

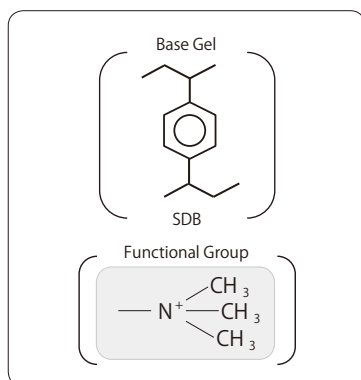

Average Particle Size : 70 μm
 Surface Area : 480 m^2/g
 Pore Volume : 1.1 mL/g
 Pore diameter : 9 nm
 Ion exchange capacity : 0.3 meq/g
 pH Range : 1-14
 Remark : Cl^- ion pair

InertSep MAX FF is a high-flow version of InertSep MAX. Effective for rapid processing of highly viscous samples.

Syringe-Barrel Cartridges

| Description | Bed Weight/Volume | Qty. | Cat.No. |
|-----------------|-------------------|---------|------------|
| InertSep MAX FF | 60 mg/3 mL | 50 pcs | 5010-62740 |
| | 150 mg/6 mL | 100 pcs | 5010-62741 |
| | 500 mg/6 mL | 30 pcs | 5010-62742 |
| | 150 mg/12 mL | 20 pcs | 5010-62743 |
| | 500 mg/20 mL | 20 pcs | 5010-62744 |

96-Well Plates

| Description | Bed Weight/Volume | Qty. | Cat.No. |
|----------------------|-------------------|------|------------|
| InertSep 96WP MAX FF | 60 mg | 1 pc | 5010-66486 |

Luer-Device Cartridges

| Description | Bed Weight/Volume | Qty. | Cat.No. |
|------------------------|-------------------|--------|------------|
| InertSep Slim-J MAX FF | 225 mg | 50 pcs | 5010-65825 |

Large-Size Cartridges(LSC)

| Description | Bed Weight/Volume | Qty. | Cat.No. |
|---------------------|-------------------|--------|------------|
| InertSep LSC MAX FF | 60 mg | 50 pcs | 5010-27591 |

Bulk Material

| Description | Volume | Cat.No. |
|-----------------|--------|------------|
| InertSep MAX FF | 10 g | 5010-69138 |
| | 100 g | 5010-69139 |

Polymer-Based SPE (Ion Exchange)

1

InertSep Series

InertSep MCX Hydrophobic polymer modified by a strong cation-exchange group

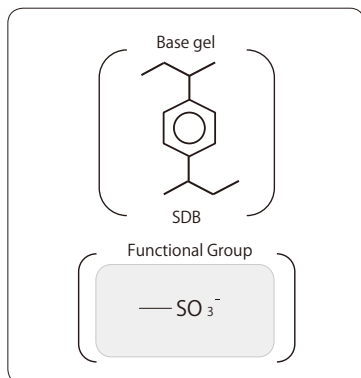

Average Particle Size : 30 μm
 Surface Area : 520 m^2/g
 Pore Volume : 1.2 mL/g
 Pore diameter : 9 nm
 pH Range : 1-14
 Ion exchange capacity : 1.3 meq/g

InertSep MCX is a mixed-mode SPE sorbent based on styrene divinylbenzene polymer modified by a strong cation-exchange group. It has a hydrophobic and a cation-exchange interaction, making it suitable for the pretreatment of weak basic compounds.

Syringe-Barrel Cartridges

| Description | Bed Weight/Volume | Qty. | Cat.No. |
|--------------|-------------------|---------|------------|
| InertSep MCX | 10 mg/1 mL | 100 pcs | 5010-62690 |
| | 30 mg/1 mL | 100 pcs | 5010-62691 |
| | 60 mg/3 mL | 50 pcs | 5010-62692 |
| | 150 mg/6 mL | 30 pcs | 5010-62693 |

Large-Size Cartridges(LSC)

| Description | Bed Weight/Volume | Qty. | Cat.No. |
|------------------|-------------------|--------|------------|
| InertSep LSC MCX | 60 mg | 50 pcs | 5010-27556 |

96 Well Plates

| Description | Bed Weight/Volume | Qty. | Cat.No. |
|-------------------|-------------------|------|------------|
| InertSep 96WP MCX | 10 mg | 1 pc | 5010-66460 |
| | 30 mg | 1 pc | 5010-66461 |
| | 60 mg | 1 pc | 5010-66462 |

InertSep MCX FF Hydrophobic polymer modified by a strong cation-exchange group

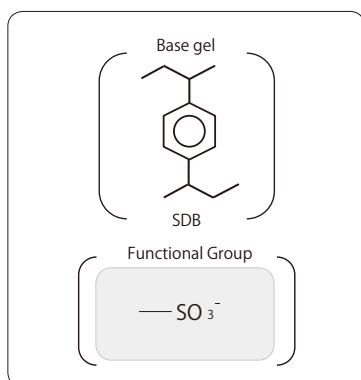

Average Particle Size : 70 μm
 Surface Area : 480 m^2/g
 Pore Volume : 1.1 mL/g
 Pore diameter : 9 nm
 Ion exchange capacity : 1.2 meq/g
 pH Range : 1-14
 Remark : H^+ ion pair

InertSep MCX FF is a high-flow version of InertSep MCX. Effective for rapid processing of highly viscous samples.

Syringe-Barrel Cartridges

| Description | Bed Weight/Volume | Qty. | Cat.No. |
|-----------------|-------------------|---------|------------|
| InertSep MCX FF | 30 mg/1 mL | 100 pcs | 5010-62705 |
| | 60 mg/3 mL | 50 pcs | 5010-62700 |
| | 150 mg/6 mL | 30 pcs | 5010-62701 |
| | 500 mg/6 mL | 30 pcs | 5010-62702 |
| | 150 mg/12 mL | 20 pcs | 5010-62703 |
| | 500 mg/20 mL | 20 pcs | 5010-62704 |
| | 1 g/20 mL | 20 pcs | 5010-62706 |

96-Well Plates

| Description | Bed Weight/Volume | Qty. | Cat.No. |
|----------------------|-------------------|------|------------|
| InertSep 96WP MCX FF | 30 mg | 1 pc | 5010-66465 |
| | 60 mg | 1 pc | 5010-66466 |

Luer-Device Cartridges

| Description | Bed Weight/Volume | Qty. | Cat.No. |
|------------------------|-------------------|--------|------------|
| InertSep Slim-J MCX FF | 225 mg | 50 pcs | 5010-65805 |

Large-Size Cartridges(LSC)

| Description | Bed Weight/Volume | Qty. | Cat.No. |
|---------------------|-------------------|--------|------------|
| InertSep LSC MCX FF | 60 mg | 50 pcs | 5010-27576 |

Bulk Material

| Description | Volume | Cat.No. |
|-----------------|--------|------------|
| InertSep MCX FF | 10 g | 5010-69134 |
| | 100 g | 5010-69135 |

Polymer-Based SPE (Ion Exchange)

1

InertSep Series

InertSep WAX Hydrophobic polymer modified by a weak anion-exchange groupe

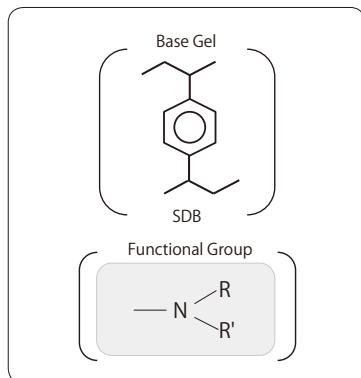

| | |
|-----------------------|-----------------------------|
| Average Particle Size | : 30 μm |
| Surface Area | : 520 m^2/g |
| Pore Volume | : 1.2 mL/g |
| Pore diameter | : 9 nm |
| pH Range | : 1-14 |
| Ion exchange capacity | : 0.5 meq/g |

InertSep WAX is a mixed-mode SPE sorbent based on styrene divinylbenzene polymer modified by a weak anion-exchange group. It has a hydrophobic and an anion-exchange interaction, making it suitable for the pretreatment of strong acidic compounds.

Syringe-Barrel Cartridges

| Description | Bed Weight/Volume | Qty. | Cat.No. |
|--------------|-------------------|---------|------------|
| InertSep WAX | 10 mg/1 mL | 100 pcs | 5010-62750 |
| | 30 mg/1 mL | 100 pcs | 5010-62751 |
| | 60 mg/3 mL | 50 pcs | 5010-62752 |
| | 150 mg/6 mL | 30 pcs | 5010-62753 |
| | 200 mg/6 mL | 30 pcs | 5010-62754 |
| | 500 mg/6 mL | 30 pcs | 5010-62755 |

96 Well Plates

| Description | Bed Weight/Volume | Qty. | Cat.No. |
|-------------------|-------------------|------|------------|
| InertSep 96WP WAX | 10 mg | 1 pc | 5010-66490 |
| | 30 mg | 1 pc | 5010-66491 |
| | 60 mg | 1 pc | 5010-66492 |

InertSep WAX FF Hydrophobic polymer modified by a weak anion-exchange groupe

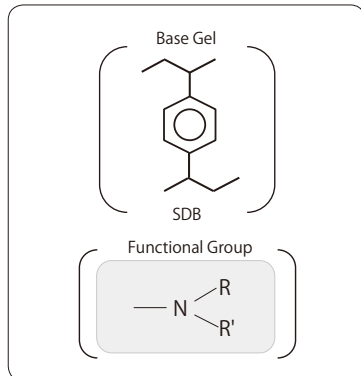

| | |
|-----------------------|-----------------------------|
| Average particle size | : 70 μm |
| Surface Area | : 480 m^2/g |
| Pore volume | : 1.1 mL/g |
| Pore diameter | : 9 nm |
| Ion exchange capacity | : 0.7 meq/g |
| pH Range | : 1-14 |
| Remark | : OH^- ion pair |

InertSep WAX FF is a high-flow version of InertSep WAX. Effective for rapid processing of highly viscous samples.

Syringe-Barrel Cartridges

| Description | Bed Weight/Volume | Qty. | Cat.No. |
|-----------------|-------------------|---------|------------|
| InertSep WAX FF | 30 mg/1 mL | 100 pcs | 5010-62765 |
| | 60 mg/3 mL | 50 pcs | 5010-62760 |
| | 150 mg/6 mL | 30 pcs | 5010-62761 |
| | 500 mg/6 mL | 30 pcs | 5010-62762 |
| | 150 mg/12 mL | 20 pcs | 5010-62763 |
| | 500 mg/20 mL | 20 pcs | 5010-62764 |

Luer-Device Cartridges

| Description | Bed Weight/Volume | Qty. | Cat.No. |
|------------------------|-------------------|--------|------------|
| InertSep Slim-J WAX FF | 225 mg | 50 pcs | 5010-65835 |

Bulk Material

| Description | Volume | Cat.No. |
|-----------------|--------|------------|
| InertSep WAX FF | 10 g | 5010-69140 |
| | 100 g | 5010-69141 |

Polymer-Based SPE (Ion Exchange)

1

InertSep Series

InertSep WCX Hydrophobic polymer modified by a weak cation-exchange group

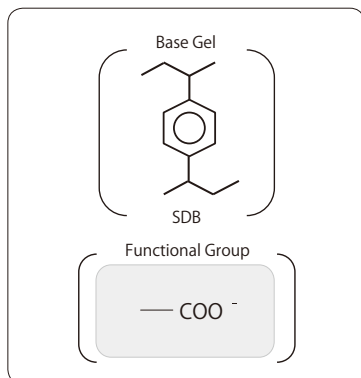

Average Particle Size : 30 μm
 Surface Area : 520 m^2/g
 Pore Volume : 1.2 mL/g
 Pore diameter : 9 nm
 pH Range : 1-14
 Ion exchange capacity : 1.5 meq/g

InertSep WCX is a mixed-mode SPE sorbent based on styrene divinylbenzene polymer modified by a weak cation-exchange group. It has a hydrophobic and a cation-exchange interaction, making it suitable for the pretreatment of strong basic compounds.

Syringe-Barrel Cartridges

| Description | Bed Weight/Volume | Qty. | Cat.No. |
|--------------|-------------------|---------|------------|
| InertSep WCX | 10 mg/1 mL | 100 pcs | 5010-62710 |
| | 30 mg/1 mL | 100 pcs | 5010-62711 |
| | 60 mg/3 mL | 50 pcs | 5010-62712 |
| | 150 mg/6 mL | 30 pcs | 5010-62713 |

96 Well Plates

| Description | Bed Weight/Volume | Qty. | Cat.No. |
|-------------------|-------------------|------|------------|
| InertSep 96WP WCX | 10 mg | 1 pc | 5010-66470 |
| | 30 mg | 1 pc | 5010-66471 |

InertSep WCX FF Hydrophobic polymer modified by a weak cation-exchange group

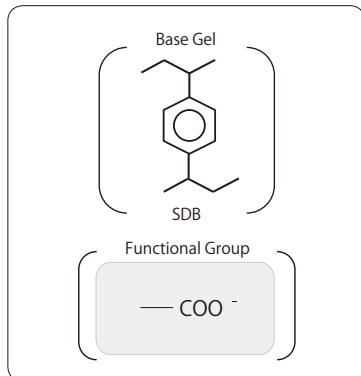

Average Particle Size : 70 μm
 Surface Area : 480 m^2/g
 Pore Volume : 1.1 mL/g
 Pore diameter : 9 nm
 Ion exchange capacity : 1.2 meq/g
 pH Range : 1-14
 Remark : H^+ ion pair

InertSep WCX FF is a high-flow version of InertSep WCX. Effective for rapid processing of highly viscous samples.

Syringe-Barrel Cartridges

| Description | Bed Weight/Volume | Qty. | Cat.No. |
|-----------------|-------------------|---------|------------|
| InertSep WCX FF | 30 mg/1 mL | 100 pcs | 5010-62725 |
| | 60 mg/3 mL | 50 pcs | 5010-62720 |
| | 150 mg/6 mL | 30 pcs | 5010-62721 |
| | 500 mg/6 mL | 30 pcs | 5010-62722 |
| | 150 mg/12 mL | 20 pcs | 5010-62723 |
| | 500 mg/20 mL | 20 pcs | 5010-62724 |

Luer-Device Cartridges

| Description | Bed Weight/Volume | Qty. | Cat.No. |
|------------------------|-------------------|--------|------------|
| InertSep Slim-J WCX FF | 225 mg | 50 pcs | 5010-65815 |

Bulk Material

| Description | Volume | Cat.No. |
|-----------------|--------|------------|
| InertSep WCX FF | 10 g | 5010-69136 |
| | 100 g | 5010-69137 |

Polymer-Based SPE (Chelate)

InertSep ME-1

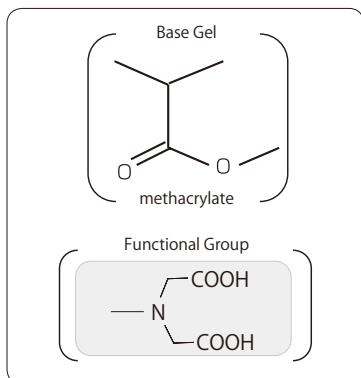

Average Particle Size : 70 μm
 Surface Area : 80 m^2/g
 Pore Volume : 0.5 mL/g
 Pore Size : 21 nm
 Ion exchange capacity : Cu^{2+} 0.3 mmol/g
 pH Range : 1-14
 Remark : H^+ ion pair

InertSep ME-1 is a methacrylate copolymer based solid sorbent modified with iminodiacetic acid, weak cation exchange functional groups. It is highly hydrophilic and does not retain monovalent Na ion or K ion, but it does retain metal divalent or more cations. This offers selective concentration of such metal ions and is suitable for custom made of Ni affinity plates for protein purification.

Syringe-Barrel Cartridges

| Description | Bed Weight/Volume | Qty.(pk unit) | Cat.No. |
|---------------|-------------------|-----------------|------------|
| InertSep ME-1 | 10 mg/1 mL | 100 pcs(50 pcs) | 5010-27403 |
| | 30 mg/1 mL | 100 pcs(50 pcs) | 5010-27404 |
| | 60 mg/3 mL | 100 pcs(50 pcs) | 5010-27405 |
| | 100 mg/3 mL | 50 pcs(25 pcs) | 5010-27400 |
| | 250 mg/6 mL | 30 pcs | 5010-27401 |
| | 500 mg/6 mL | 30 pcs | 5010-27402 |
| | 1 g/20 mL | 20 pcs(10 pcs) | 5010-27406 |
| | 2 g/20 mL | 20 pcs(10 pcs) | 5010-27407 |

Large-Size Cartridges (LSC)

| Description | Bed Weight/Volume | Qty.(pk unit) | Cat.No. |
|-------------------|-------------------|----------------|------------|
| InertSep LSC ME-1 | 10 mg | 50 pcs(25 pcs) | 5010-27670 |
| | 30 mg | 50 pcs(25 pcs) | 5010-27671 |
| | 60 mg | 50 pcs(25 pcs) | 5010-27672 |
| | 200 mg | 50 pcs(25 pcs) | 5010-27673 |
| | 500 mg | 50 pcs(25 pcs) | 5010-27674 |

Luer-Device Cartridges

| Description | Bed Weight/Volume | Qty. | Cat.No. |
|--------------------|-------------------|--------|------------|
| InertSep mini ME-1 | 280 mg | 50 pcs | 5010-27215 |

96-Well Plates

| Description | Bed Weight/Volume | Qty. | Cat.No. |
|--------------------|-------------------|------|------------|
| InertSep 96WP ME-1 | 30 mg | 1 pc | 5010-66800 |
| | 60 mg | 1 pc | 5010-66801 |

Bulk Material

| Description | Volume | Cat.No. |
|---------------|--------|------------|
| InertSep ME-1 | 10 g | 5010-69126 |
| | 100 g | 5010-69127 |

Polymer-Based SPE (Chelate)

InertSep ME-2

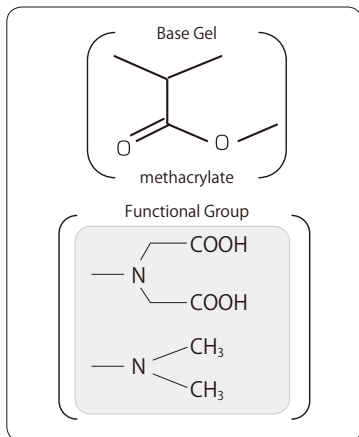

Average Particle Size : 70 μm
 Surface Area : 80 m^2/g
 Pore Volume : 0.5 mL/g
 Pore Size : 21 nm
 Ion exchange capacity : Cu^{2+} 0.3 mmol/g
 pH Range : 1-14
 Remark : H^+ ion pair

InertSep ME-2 is a chelating resin sorbent, developed for SPE of trace metal ions in seawater. As this sorbent does not retain Ca and Mg ions, desalting can be achieved by passing the sample through the sorbent and wash with purified water.

Syringe-Barrel Cartridges

| Description | Bed Weight/Volume | Qty.(pk unit) | Cat.No. |
|---------------|-------------------|-----------------|------------|
| InertSep ME-2 | 10 mg/1 mL | 100 pcs(50 pcs) | 5010-27413 |
| | 30 mg/1 mL | 100 pcs(50 pcs) | 5010-27414 |
| | 60 mg/3 mL | 100 pcs(50 pcs) | 5010-27415 |
| | 100 mg/3 mL | 50 pcs(25 pcs) | 5010-27410 |
| | 250 mg/6 mL | 30 pcs | 5010-27411 |
| | 500 mg/6 mL | 30 pcs | 5010-27412 |
| | 1 g/20 mL | 20 pcs(10 pcs) | 5010-27416 |
| | 2 g/20 mL | 20 pcs(10 pcs) | 5010-27417 |

Large-Size Cartridges (LSC)

| Description | Bed Weight/Volume | Qty.(pk unit) | Cat.No. |
|-------------------|-------------------|----------------|------------|
| InertSep LSC ME-2 | 30 mg | 50 pcs(25 pcs) | 5010-27681 |
| | 60 mg | 50 pcs(25 pcs) | 5010-27682 |
| | 200 mg | 50 pcs(25 pcs) | 5010-27683 |
| | 500 mg | 50 pcs(25 pcs) | 5010-27684 |

Luer-Device Cartridges

| Description | Bed Weight/Volume | Qty. | Cat.No. |
|--------------------|-------------------|--------|------------|
| InertSep mini ME-2 | 280 mg | 50 pcs | 5010-27216 |

Bulk Material

| Description | Volume | Cat.No. |
|---------------|--------|------------|
| InertSep ME-2 | 10 g | 5010-69128 |
| | 100 g | 5010-69129 |

Silica-Based SPE (Non-Polar)

1

InertSep Series

InertSep C18

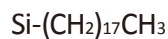

| | |
|-----------------------|-------------------------|
| Average Particle Size | : 60 μm |
| Carbon Load | : 19 % |
| End-Capping | : High |
| Surface Area | : 450 m ² /g |
| Pore Volume | : 0.7 mL/g |
| Pore Size | : 6 nm |
| pH Range | : 2-8 |

InertSep C18 is a silica-based sorbent modified with C18 for non-polar interactions. With our high-level end-capping technology, cation exchange by interaction with the residual silanol groups is suppressed, which reduces adsorption of basic compounds. This sorbent is suitable for removing lipid for simultaneous analysis of pesticide residues in agricultural products.

Syringe-Barrel Cartridges

| Description | Bed Weight/Volume | Qty.(pk unit) | Cat.No. |
|--------------|-------------------|----------------|------------|
| InertSep C18 | 50 mg/1 mL | 100 pcs | 5010-61000 |
| | 100 mg/1 mL | 100 pcs | 5010-61001 |
| | 200 mg/1 mL | 50 pcs | 5010-61016 |
| | 200 mg/3 mL | 50 pcs | 5010-61002 |
| | 500 mg/3 mL | 50 pcs | 5010-61003 |
| | 500 mg/6 mL | 30 pcs | 5010-61004 |
| | 500 mg/20 mL | 20 pcs(10 pcs) | 5010-61013 |
| | 1 g/6 mL | 30 pcs | 5010-61005 |
| | 1 g/12 mL | 20 pcs | 5010-61015 |
| | 2 g/12 mL | 20 pcs | 5010-61006 |
| | 1 g/20 mL | 20 pcs(10 pcs) | 5010-61014 |
| | 5 g/20 mL | 20 pcs(10 pcs) | 5010-61007 |
| | 10 g/60 mL | 16 pcs(4 pcs) | 5010-61008 |
| | 20 g/60 mL | 16 pcs(4 pcs) | 5010-61009 |
| | 25 g/150 mL | 8 pcs(1 pc) | 5010-61010 |
| | 50 g/150 mL | 8 pcs(1 pc) | 5010-61011 |
| 70 g/150 mL | 8 pcs(1 pc) | 5010-61012 | |

Large-Size Cartridges (LSC)

| Description | Bed Weight/Volume | Qty.(pk unit) | Cat.No. |
|------------------|-------------------|----------------|------------|
| InertSep LSC C18 | 100 mg | 50 pcs(25 pcs) | 5010-63001 |
| | 200 mg | 50 pcs(25 pcs) | 5010-63002 |
| | 500 mg | 50 pcs(25 pcs) | 5010-63003 |

Luer-Device Cartridges

| Description | Bed Weight/Volume | Qty. | Cat.No. |
|---------------------|-------------------|--------|------------|
| InertSep Slim-J C18 | 500 mg | 50 pcs | 5010-65000 |
| | 1000 mg | 50 pcs | 5010-65001 |
| InertSep Slim C18 | 400 mg | 50 pcs | 5010-65005 |
| | 900 mg | 50 pcs | 5010-65006 |

96-Well Plates

| Description | Bed Weight/Volume | Qty. | Cat.No. |
|-------------------|-------------------|------|------------|
| InertSep 96WP C18 | 50 mg | 1 pc | 5010-66000 |
| | 100 mg | 1 pc | 5010-66001 |

Bulk Material

| Description | Volume | Cat.No. |
|--------------|--------|------------|
| InertSep C18 | 100 g | 5010-69000 |

Silica-Based SPE (Non-Polar)

1

InertSep Series

InertSep C18 FF

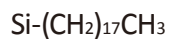

Average Particle Size : 120 μm
 Carbon Load : 19 %
 End-Capping : High
 Surface Area : 450 m^2/g
 Pore Volume : 0.7 mL/g
 Pore Size : 6 nm
 pH Range : 2-8

InertSep C18 FF is a modified version of InertSep C18 for high flow lates. This sorbent is also suitable for viscous biological samples and large volume samples to increase the throughput.

Syringe-Barrel Cartridges

| Description | Bed Weight/Volume | Qty.(pk unit) | Cat.No. |
|-----------------|-------------------|----------------|------------|
| InertSep C18 FF | 50 mg/1 mL | 100 pcs | 5010-62000 |
| | 100 mg/1 mL | 100 pcs | 5010-62001 |
| | 200 mg/3 mL | 50 pcs | 5010-62002 |
| | 500 mg/3 mL | 50 pcs | 5010-62003 |
| | 500 mg/6 mL | 30 pcs | 5010-62004 |
| | 1 g/6 mL | 30 pcs | 5010-62005 |
| | 2 g/12 mL | 20 pcs | 5010-62006 |
| | 5 g/20 mL | 20 pcs(10 pcs) | 5010-62007 |
| | 10 g/60 mL | 16 pcs(4 pcs) | 5010-62008 |
| | 20 g/60 mL | 16 pcs(4 pcs) | 5010-62009 |
| | 25 g/150 mL | 8 pcs(1 pc) | 5010-62010 |
| | 50 g/150 mL | 8 pcs(1 pc) | 5010-62011 |
| | 70 g/150 mL | 8 pcs(1 pc) | 5010-62012 |

Large-Size Cartridges (LSC)

| Description | Bed Weight/Volume | Qty.(pk unit) | Cat.No. |
|---------------------|-------------------|----------------|------------|
| InertSep LSC C18 FF | 100 mg | 50 pcs(25 pcs) | 5010-64001 |
| | 200 mg | 50 pcs(25 pcs) | 5010-64002 |
| | 500 mg | 50 pcs(25 pcs) | 5010-64003 |

96-Well Plates

| Description | Bed Weight/Volume | Qty. | Cat.No. |
|----------------------|-------------------|------|------------|
| InertSep 96WP C18 FF | 50 mg | 1 pc | 5010-66010 |
| | 100 mg | 1 pc | 5010-66011 |

Bulk Material

| Description | Volume | Cat.No. |
|-----------------|--------|------------|
| InertSep C18 FF | 100 g | 5010-69024 |

Silica-Based SPE (Non-Polar)

InertSep C18-B

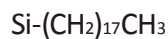

Average Particle Size : 45 μm
 Carbon Load : 14 %
 End-Capping : Middle
 Surface Area : 450 m²/g
 Pore Volume : 0.7 mL/g
 Pore Size : 6 nm
 pH Range : 2-8

InertSep C18-B is a silica-based sorbent modified with monofunctional C18 groups for non-polar interactions. In addition to the interaction, secondary interaction can be expected.

Syringe-Barrel Cartridges

| Description | Bed Weight/Volume | Qty.(pk unit) | Cat.No. |
|----------------|-------------------|----------------|------------|
| InertSep C18-B | 50 mg/1 mL | 100 pcs | 5010-61020 |
| | 100 mg/1 mL | 100 pcs | 5010-61021 |
| | 200 mg/3 mL | 50 pcs | 5010-61022 |
| | 500 mg/3 mL | 50 pcs | 5010-61023 |
| | 500 mg/6 mL | 30 pcs | 5010-61024 |
| | 1 g/6 mL | 30 pcs | 5010-61025 |
| | 2 g/12 mL | 20 pcs | 5010-61026 |
| | 5 g/20 mL | 20 pcs(10 pcs) | 5010-61027 |
| | 10 g/60 mL | 16 pcs(4 pcs) | 5010-61028 |

Large-Size Cartridges (LSC)

| Description | Bed Weight/Volume | Qty.(pk unit) | Cat.No. |
|--------------------|-------------------|----------------|------------|
| InertSep LSC C18-B | 100 mg | 50 pcs(25 pcs) | 5010-63021 |
| | 200 mg | 50 pcs(25 pcs) | 5010-63022 |
| | 500 mg | 50 pcs(25 pcs) | 5010-63023 |

Luer-Device Cartridges

| Description | Bed Weight/Volume | Qty. | Cat.No. |
|-----------------------|-------------------|--------|------------|
| InertSep Slim-J C18-B | 500 mg | 50 pcs | 5010-65020 |
| | 1000 mg | 50 pcs | 5010-65021 |
| InertSep Slim C18-B | 360 mg | 50 pcs | 5010-65025 |
| | 840 mg | 50 pcs | 5010-65026 |

96-Well Plates

| Description | Bed Weight/Volume | Qty. | Cat.No. |
|---------------------|-------------------|------|------------|
| InertSep 96WP C18-B | 50 mg | 1 pc | 5010-66020 |
| | 100 mg | 1 pc | 5010-66021 |

Bulk Material

| Description | Volume | Cat.No. |
|----------------|--------|------------|
| InertSep C18-B | 100 g | 5010-69001 |

Silica-Based SPE (Non-Polar)

InertSep C18-C

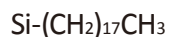

| | |
|-----------------------|-------------------------|
| Average Particle Size | : 60 µm |
| Carbon Load | : 16 % |
| End-Capping | : Low |
| Surface Area | : 450 m ² /g |
| Pore Volume | : 0.7 mL/g |
| Pore Size | : 6 nm |
| pH Range | : 2-8 |

InertSep C18-C is a silica-based sorbent modified with trifunctional C18 groups for non-polar interactions. In addition to the non-polar interactions, secondary interaction between unbonded silanol groups on silica substrate and analytes can be expected.

Syringe-Barrel Cartridges

| Description | Bed Weight/Volume | Qty.(pk unit) | Cat.No. |
|----------------|-------------------|----------------|------------|
| InertSep C18-C | 50 mg/1 mL | 100 pcs | 5010-61040 |
| | 100 mg/1 mL | 100 pcs | 5010-61041 |
| | 200 mg/3 mL | 50 pcs | 5010-61042 |
| | 500 mg/3 mL | 50 pcs | 5010-61043 |
| | 500 mg/6 mL | 30 pcs | 5010-61044 |
| | 1 g/6 mL | 30 pcs | 5010-61045 |
| | 2 g/12 mL | 20 pcs | 5010-61046 |
| | 5 g/20 mL | 20 pcs(10 pcs) | 5010-61047 |
| | 10 g/60 mL | 16 pcs(4 pcs) | 5010-61048 |
| | 20 g/60 mL | 16 pcs(4 pcs) | 5010-61049 |
| | 25 g/150 mL | 8 pcs(1 pc) | 5010-61050 |
| | 50 g/150 mL | 8 pcs(1 pc) | 5010-61051 |
| | 70 g/150 mL | 8 pcs(1 pc) | 5010-61052 |

Large-Size Cartridges (LSC)

| Description | Bed Weight/Volume | Qty.(pk unit) | Cat.No. |
|--------------------|-------------------|----------------|------------|
| InertSep LSC C18-C | 100 mg | 50 pcs(25 pcs) | 5010-63041 |
| | 200 mg | 50 pcs(25 pcs) | 5010-63042 |
| | 500 mg | 50 pcs(25 pcs) | 5010-63043 |

Luer-Device Cartridges

| Description | Bed Weight/Volume | Qty. | Cat.No. |
|-----------------------|-------------------|--------|------------|
| InertSep Slim-J C18-C | 500 mg | 50 pcs | 5010-65040 |
| | 1000 mg | 50 pcs | 5010-65041 |
| InertSep Slim C18-C | 360 mg | 50 pcs | 5010-65045 |
| | 840 mg | 50 pcs | 5010-65046 |

96-Well Plates

| Description | Bed Weight/Volume | Qty. | Cat.No. |
|---------------------|-------------------|------|------------|
| InertSep 96WP C18-C | 50 mg | 1 pc | 5010-66030 |
| | 100 mg | 1 pc | 5010-66031 |

Bulk Material

| Description | Volume | Cat.No. |
|----------------|--------|------------|
| InertSep C18-C | 100 g | 5010-69002 |

Silica-Based SPE (Non-Polar)

InertSep C18-C FF

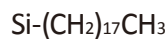

Average Particle Size : 120 μm
 Carbon Load : 16 %
 End-Capping : Low
 Surface Area : 450 m^2/g
 Pore Volume : 0.7 mL/g
 Pore Size : 6 nm
 pH Range : 2-8

InertSep C18-C FF is a modified version of InertSep C18-C for high flow rates. This sorbent is also suitable for viscous biological samples and large volume samples to increase the throughput.

Syringe-Barrel Cartridges

| Description | Bed Weight/Volume | Qty.(pk unit) | Cat.No. |
|-------------------|-------------------|----------------|------------|
| InertSep C18-C FF | 50 mg/1 mL | 100 pcs | 5010-62040 |
| | 100 mg/1 mL | 100 pcs | 5010-62041 |
| | 200 mg/3 mL | 50 pcs | 5010-62042 |
| | 500 mg/3 mL | 50 pcs | 5010-62043 |
| | 500 mg/6 mL | 30 pcs | 5010-62044 |
| | 1 g/6 mL | 30 pcs | 5010-62045 |
| | 2 g/12 mL | 20 pcs | 5010-62046 |
| | 5 g/20 mL | 20 pcs(10 pcs) | 5010-62047 |
| | 10 g/60 mL | 16 pcs(4 pcs) | 5010-62048 |
| | 20 g/60 mL | 16 pcs(4 pcs) | 5010-62049 |
| | 25 g/150 mL | 8 pcs(1 pc) | 5010-62050 |
| | 50 g/150 mL | 8 pcs(1 pc) | 5010-62051 |
| | 70 g/150 mL | 8 pcs(1 pc) | 5010-62052 |

Large-Size Cartridges (LSC)

| Description | Bed Weight/Volume | Qty.(pk unit) | Cat.No. |
|-----------------------|-------------------|----------------|------------|
| InertSep LSC C18-C FF | 100 mg | 50 pcs(25 pcs) | 5010-64041 |
| | 200 mg | 50 pcs(25 pcs) | 5010-64042 |
| | 500 mg | 50 pcs(25 pcs) | 5010-64043 |

96-Well Plates

| Description | Bed Weight/Volume | Qty. | Cat.No. |
|------------------------|-------------------|------|------------|
| InertSep 96WP C18-C FF | 50 mg | 1 pc | 5010-66040 |
| | 100 mg | 1 pc | 5010-66041 |

Bulk Material

| Description | Volume | Cat.No. |
|-------------------|--------|------------|
| InertSep C18-C FF | 100 g | 5010-69026 |

Silica-Based SPE (Non-Polar)

InertSep C18-ENV

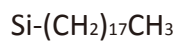

| | |
|-----------------------|-------------------------|
| Average Particle Size | : 60 µm |
| Carbon Load | : 16 % |
| End-Capping | : Low |
| Surface Area | : 450 m ² /g |
| Pore Volume | : 0.7 mL/g |
| Pore Size | : 6 nm |
| pH Range | : 2-8 |

InertSep C18-ENV is a C18 solid phase synthesized for water quality analysis, and can be used for anionic surfactant pretreatment in water.

Syringe-Barrel Cartridges

| Description | Bed Weight/Volume | Qty. | Cat.No. |
|------------------|-------------------|--------|------------|
| InertSep C18-ENV | 500 mg/6 mL | 30 pcs | 5010-61204 |

Luer-Device Cartridges

| Description | Bed Weight/Volume | Qty. | Cat.No. |
|-------------------------|-------------------|---------|------------|
| InertSep Slim-J C18-ENV | 500 mg | 50 pcs | 5010-65200 |
| | 500 mg | 500 pcs | 5010-65205 |
| | 1000 mg | 50 pcs | 5010-65201 |

Silica-Based SPE (Non-Polar)

1

InertSep Series

InertSep C8

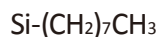

Average Particle Size : 60 μm
 Carbon Load : 12 %
 End-Capping : Middle
 Surface Area : 450 m²/g
 Pore Volume : 0.7 mL/g
 Pore Size : 6 nm
 pH Range : 2-8

InertSep C8 is a silica-based sorbent modified with C8 (octyl) function groups that offers a weaker non-polar interaction than C18. InertSep C8 is used for isolates that are strongly retained too much on C18. With high-level end-capping, cationic interaction with the silanol groups on silica substrate is virtually eliminated and adsorption of basic compounds is reduced.

Syringe-Barrel Cartridges

| Description | Bed Weight/Volume | Qty.(pk unit) | Cat.No. |
|-------------|-------------------|----------------|------------|
| InertSep C8 | 50 mg/1 mL | 100 pcs | 5010-61080 |
| | 100 mg/1 mL | 100 pcs | 5010-61081 |
| | 200 mg/3 mL | 50 pcs | 5010-61082 |
| | 500 mg/3 mL | 50 pcs | 5010-61083 |
| | 500 mg/6 mL | 30 pcs | 5010-61084 |
| | 1 g/6 mL | 30 pcs | 5010-61085 |
| | 2 g/12 mL | 20 pcs | 5010-61086 |
| | 5 g/20 mL | 20 pcs(10 pcs) | 5010-61087 |
| | 10 g/60 mL | 16 pcs(4 pcs) | 5010-61088 |
| | 20 g/60 mL | 16 pcs(4 pcs) | 5010-61089 |
| | 25 g/150 mL | 8 pcs(1 pc) | 5010-61090 |
| | 50 g/150 mL | 8 pcs(1 pc) | 5010-61091 |
| | 70 g/150 mL | 8 pcs(1 pc) | 5010-61092 |

Large-Size Cartridges (LSC)

| Description | Bed Weight/Volume | Qty.(pk unit) | Cat.No. |
|-----------------|-------------------|----------------|------------|
| InertSep LSC C8 | 100 mg | 50 pcs(25 pcs) | 5010-63081 |
| | 200 mg | 50 pcs(25 pcs) | 5010-63082 |
| | 500 mg | 50 pcs(25 pcs) | 5010-63083 |

Luer-Device Cartridges

| Description | Bed Weight/Volume | Qty. | Cat.No. |
|--------------------|-------------------|--------|------------|
| InertSep Slim-J C8 | 500 mg | 50 pcs | 5010-65080 |
| | 1000 mg | 50 pcs | 5010-65081 |

96-Well Plates

| Description | Bed Weight/Volume | Qty. | Cat.No. |
|------------------|-------------------|------|------------|
| InertSep 96WP C8 | 50 mg | 1 pc | 5010-66050 |
| | 100 mg | 1 pc | 5010-66051 |

Bulk Material

| Description | Volume | Cat.No. |
|-------------|--------|------------|
| InertSep C8 | 100 g | 5010-69003 |

Silica-Based SPE (Non-Polar)

InertSep C2

Si-C₂H₅

Average Particle Size : 60 μm
 Carbon Load : 5.5 %
 End-Capping : Middle
 Surface Area : 450 m²/g
 Pore Volume : 0.7 mL/g
 Pore Size : 6 nm
 pH Range : 2-8

InertSep C2 is a silica-based sorbent modified with C2 (ethyl) functional groups being utilized for a weaker non-polar interaction than C8. InertSep C2 is used for isolates that are strongly retained too much on C8. As end-capping is accomplished on this sorbent, cation exchange interaction with none bonded silanol groups is virtually eliminated resulting in reduced adsorption of basic compounds.

Syringe-Barrel Cartridges

| Description | Bed Weight/Volume | Qty.(pk unit) | Cat.No. |
|-------------|-------------------|----------------|------------|
| InertSep C2 | 50 mg/1 mL | 100 pcs | 5010-61120 |
| | 100 mg/1 mL | 100 pcs | 5010-61121 |
| | 200 mg/3 mL | 50 pcs | 5010-61122 |
| | 500 mg/3 mL | 50 pcs | 5010-61123 |
| | 500 mg/6 mL | 30 pcs | 5010-61124 |
| | 1 g/6 mL | 30 pcs | 5010-61125 |
| | 2 g/12 mL | 20 pcs | 5010-61126 |
| | 5 g/20 mL | 20 pcs(10 pcs) | 5010-61127 |
| | 10 g/60 mL | 16 pcs(4 pcs) | 5010-61128 |
| | 20 g/60 mL | 16 pcs(4 pcs) | 5010-61129 |
| | 25 g/150 mL | 8 pcs(1 pc) | 5010-61130 |
| | 50 g/150 mL | 8 pcs(1 pc) | 5010-61131 |
| | 70 g/150 mL | 8 pcs(1 pc) | 5010-61132 |

Large-Size Cartridges (LSC)

| Description | Bed Weight/Volume | Qty.(pk unit) | Cat.No. |
|-----------------|-------------------|----------------|------------|
| InertSep LSC C2 | 100 mg | 50 pcs(25 pcs) | 5010-63121 |
| | 200 mg | 50 pcs(25 pcs) | 5010-63122 |
| | 500 mg | 50 pcs(25 pcs) | 5010-63123 |

Luer-Device Cartridges

| Description | Bed Weight/Volume | Qty. | Cat.No. |
|--------------------|-------------------|--------|------------|
| InertSep Slim-J C2 | 500 mg | 50 pcs | 5010-65120 |
| | 1000 mg | 50 pcs | 5010-65121 |

96-Well Plates

| Description | Bed Weight/Volume | Qty. | Cat.No. |
|------------------|-------------------|------|------------|
| InertSep 96WP C2 | 50 mg | 1 pc | 5010-66070 |
| | 100 mg | 1 pc | 5010-66071 |

Bulk Material

| Description | Volume | Cat.No. |
|-------------|--------|------------|
| InertSep C2 | 100 g | 5010-69005 |

Silica-Based SPE (Non-Polar)

InertSep CH

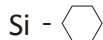

| | |
|-----------------------|-------------------------|
| Average Particle Size | : 60 µm |
| Carbon Load | : 7.5 % |
| End-Capping | : Middle |
| Surface Area | : 450 m ² /g |
| Pore Volume | : 0.7 mL/g |
| Pore Size | : 6 nm |
| pH Range | : 2-8 |

InertSep CH is a silica-based sorbent modified with cyclohexyl functional groups that gives this sorbent a similar moderate polarity with InertSep C2. InertSep CH offers a unique selectivity for the extraction of certain chemical compounds, compared with C18, C8, C2 and PH.

Syringe-Barrel Cartridges

| Description | Bed Weight/Volume | Qty.(pk unit) | Cat.No. |
|-------------|-------------------|----------------|------------|
| InertSep CH | 50 mg/1 mL | 100 pcs | 5010-61160 |
| | 100 mg/1 mL | 100 pcs | 5010-61161 |
| | 200 mg/3 mL | 50 pcs | 5010-61162 |
| | 500 mg/3 mL | 50 pcs | 5010-61163 |
| | 500 mg/6 mL | 30 pcs | 5010-61164 |
| | 1 g/6 mL | 30 pcs | 5010-61165 |
| | 2 g/12 mL | 20 pcs | 5010-61166 |
| | 5 g/20 mL | 20 pcs(10 pcs) | 5010-61167 |
| | 10 g/60 mL | 16 pcs(4 pcs) | 5010-61168 |

Large-Size Cartridges (LSC)

| Description | Bed Weight/Volume | Qty.(pk unit) | Cat.No. |
|-----------------|-------------------|----------------|------------|
| InertSep LSC CH | 100 mg | 50 pcs(25 pcs) | 5010-63161 |
| | 200 mg | 50 pcs(25 pcs) | 5010-63162 |
| | 500 mg | 50 pcs(25 pcs) | 5010-63163 |

Luer-Device Cartridges

| Description | Bed Weight/Volume | Qty. | Cat.No. |
|--------------------|-------------------|--------|------------|
| InertSep Slim-J CH | 500 mg | 50 pcs | 5010-65160 |
| | 1000 mg | 50 pcs | 5010-65161 |

96-Well Plates

| Description | Bed Weight/Volume | Qty. | Cat.No. |
|------------------|-------------------|------|------------|
| InertSep 96WP CH | 50 mg | 1 pc | 5010-66090 |
| | 100 mg | 1 pc | 5010-66091 |

Bulk Material

| Description | Volume | Cat.No. |
|-------------|--------|------------|
| InertSep CH | 100 g | 5010-69007 |

Silica-Based SPE (Non-Polar)

InertSep PH

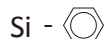

Average Particle Size : 60 μm
 Carbon Load : 10 %
 End-Capping : Middle
 Surface Area : 450 m^2/g
 Pore Volume : 0.7 mL/g
 Pore Size : 6 nm
 pH Range : 2-8

InertSep PH is a silica-based sorbent modified with phenyl functional groups having a similar non-polar interaction to C8. Phenyl functional group has π - π bond interaction which allows an isolate molecule bearing benzene ring, such as aromatic compounds to selectively interact with phenyl functional group on the sorbent.

Syringe-Barrel Cartridges

| Description | Bed Weight/Volume | Qty.(pk unit) | Cat.No. |
|-------------|-------------------|----------------|------------|
| InertSep PH | 50 mg/1 mL | 100 pcs | 5010-61180 |
| | 100 mg/1 mL | 100 pcs | 5010-61181 |
| | 200 mg/3 mL | 50 pcs | 5010-61182 |
| | 500 mg/3 mL | 50 pcs | 5010-61183 |
| | 500 mg/6 mL | 30 pcs | 5010-61184 |
| | 1 g/6 mL | 30 pcs | 5010-61185 |
| | 2 g/12 mL | 20 pcs | 5010-61186 |
| | 5 g/20 mL | 20 pcs(10 pcs) | 5010-61187 |
| | 10 g/60 mL | 16 pcs(4 pcs) | 5010-61188 |
| | 20 g/60 mL | 16 pcs(4 pcs) | 5010-61189 |
| | 25 g/150 mL | 8 pcs(1 pc) | 5010-61190 |
| | 50 g/150 mL | 8 pcs(1 pc) | 5010-61191 |
| | 70 g/150 mL | 8 pcs(1 pc) | 5010-61192 |

Large-Size Cartridges (LSC)

| Description | Bed Weight/Volume | Qty.(pk unit) | Cat.No. |
|-----------------|-------------------|----------------|------------|
| InertSep LSC PH | 100 mg | 50 pcs(25 pcs) | 5010-63181 |
| | 200 mg | 50 pcs(25 pcs) | 5010-63182 |
| | 500 mg | 50 pcs(25 pcs) | 5010-63183 |

Luer-Device Cartridges

| Description | Bed Weight/Volume | Qty. | Cat.No. |
|--------------------|-------------------|--------|------------|
| InertSep Slim-J PH | 500 mg | 50 pcs | 5010-65180 |
| | 1000 mg | 50 pcs | 5010-65181 |

96-Well Plates

| Description | Bed Weight/Volume | Qty. | Cat.No. |
|------------------|-------------------|------|------------|
| InertSep 96WP PH | 50 mg | 1 pc | 5010-66100 |
| | 100 mg | 1 pc | 5010-66101 |

Bulk Material

| Description | Volume | Cat.No. |
|-------------|--------|------------|
| InertSep PH | 100 g | 5010-69008 |

Silica-Based SPE (Polar)

1

InertSep Series

InertSep CN

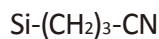

Average Particle Size : 45 μm
 Carbon Load : 7.5 %
 Surface Area : 450 m^2/g
 Pore Volume : 0.7 mL/g
 Pore Size : 6 nm
 pH Range : 2-8

InertSep CN is a silica-based sorbent modified with cyanopropyl functional groups. Having both non-polar and polar interactions, InertSep CN is ideal for applications in which extremely non-polar isolates would irreversibly retain on more non-polar sorbents such as C18 or C8 and very polar isolates might be retained irreversibly on the most polar sorbents such as SI or 2OH.

Syringe-Barrel Cartridges

| Description | Bed Weight/Volume | Qty.(pk unit) | Cat.No. |
|-------------|-------------------|----------------|------------|
| InertSep CN | 50 mg/1 mL | 100 pcs(5 pcs) | 5010-61300 |
| | 100 mg/1 mL | 100 pcs(5 pcs) | 5010-61301 |
| | 200 mg/3 mL | 50 pcs(5 pcs) | 5010-61302 |
| | 500 mg/3 mL | 50 pcs(1 pc) | 5010-61303 |
| | 500 mg/6 mL | 30 pcs(1 pc) | 5010-61304 |
| | 1 g/6 mL | 30 pcs(1 pc) | 5010-61305 |
| | 2 g/12 mL | 20 pcs(1 pc) | 5010-61306 |
| | 5 g/20 mL | 20 pcs(1 pc) | 5010-61307 |
| | 10 g/60 mL | 16 pcs(1 pc) | 5010-61308 |

Large-Size Cartridges (LSC)

| Description | Bed Weight/Volume | Qty.(pk unit) | Cat.No. |
|-----------------|-------------------|---------------|------------|
| InertSep LSC CN | 100 mg | 50 pcs(1 pc) | 5010-63301 |
| | 200 mg | 50 pcs(1 pc) | 5010-63302 |
| | 500 mg | 50 pcs(1 pc) | 5010-63303 |

Luer-Device Cartridges

| Description | Bed Weight/Volume | Qty.(pk unit) | Cat.No. |
|--------------------|-------------------|---------------|------------|
| InertSep Slim-J CN | 500 mg | 50 pcs(5 pcs) | 5010-65300 |
| | 1000 mg | 50 pcs(5 pcs) | 5010-65301 |

96-Well Plates

| Description | Bed Weight/Volume | Qty. | Cat.No. |
|------------------|-------------------|------|------------|
| InertSep 96WP CN | 50 mg | 1 pc | 5010-66300 |
| | 100 mg | 1 pc | 5010-66301 |

Bulk Material

| Description | Volume | Cat.No. |
|-------------|--------|------------|
| InertSep CN | 100 g | 5010-69009 |

Silica-Based SPE (Polar)

InertSep 2OH

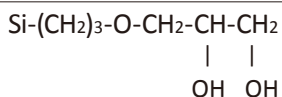

Average Particle Size : 60 μm
 Carbon Load : 10 %
 Surface Area : 450 m²/g
 Pore Volume : 0.7 mL/g
 Pore Size : 6 nm
 pH Range : 2-8

InertSep 2OH is a silica-based sorbent modified with diol functional groups. Being a fairly polar sorbent, InertSep 2OH is typically used for polar extractions from low-polar or non-polar solvents.

Syringe-Barrel Cartridges

| Description | Bed Weight/Volume | Qty.(pk unit) | Cat.No. |
|--------------|-------------------|----------------|------------|
| InertSep 2OH | 50 mg/1 mL | 100 pcs(5 pcs) | 5010-61320 |
| | 100 mg/1 mL | 100 pcs(5 pcs) | 5010-61321 |
| | 200 mg/3 mL | 50 pcs(5 pcs) | 5010-61322 |
| | 500 mg/3 mL | 50 pcs(1 pc) | 5010-61323 |
| | 500 mg/6 mL | 30 pcs(1 pc) | 5010-61324 |
| | 1 g/6 mL | 30 pcs(1 pc) | 5010-61325 |
| | 2 g/12 mL | 20 pcs(1 pc) | 5010-61326 |
| | 5 g/20 mL | 20 pcs(1 pc) | 5010-61327 |
| | 10 g/60 mL | 16 pcs(1 pc) | 5010-61328 |
| | 20 g/60 mL | 16 pcs(1 pc) | 5010-61329 |
| | 25 g/150 mL | 8 pcs(1 pc) | 5010-61330 |
| | 50 g/150 mL | 8 pcs(1 pc) | 5010-61331 |
| 70 g/150 mL | 8 pcs(1 pc) | 5010-61332 | |

Large-Size Cartridges (LSC)

| Description | Bed Weight/Volume | Qty.(pk unit) | Cat.No. |
|------------------|-------------------|---------------|------------|
| InertSep LSC 2OH | 100 mg | 50 pcs(1 pc) | 5010-63321 |
| | 200 mg | 50 pcs(1 pc) | 5010-63322 |
| | 500 mg | 50 pcs(1 pc) | 5010-63323 |

Luer-Device Cartridges

| Description | Bed Weight/Volume | Qty.(pk unit) | Cat.No. |
|---------------------|-------------------|---------------|------------|
| InertSep Slim-J 2OH | 500 mg | 50 pcs(5 pcs) | 5010-65320 |
| | 1000 mg | 50 pcs(5 pcs) | 5010-65321 |
| InertSep Slim 2OH | 360 mg | 50 pcs(5 pcs) | 5010-65325 |

96-Well Plates

| Description | Bed Weight/Volume | Qty. | Cat.No. |
|-------------------|-------------------|------|------------|
| InertSep 96WP 2OH | 50 mg | 1 pc | 5010-66310 |
| | 100 mg | 1 pc | 5010-66311 |

Bulk Material

| Description | Volume | Cat.No. |
|--------------|--------|------------|
| InertSep 2OH | 100 g | 5010-69010 |

InertSep SI

Si-OH

Average Particle Size : 60 μm
 Surface Area : 450 m^2/g
 Pore Volume : 0.7 mL/g
 Pore Size : 6 nm
 pH Range : 2-8

InertSep SI is a bare silica, which has strong polar interaction. It offers selective separation for similar compounds in structure using low-polar solvents. InertSep SI is regarded as the most polar sorbent available. Care should be taken with humidity and polar solvents, when using this material.

Syringe-Barrel Cartridges

| Description | Bed Weight/Volume | Qty.(pk unit) | Cat.No. |
|-------------|-------------------|----------------|------------|
| InertSep SI | 50 mg/1 mL | 100 pcs(5 pcs) | 5010-61340 |
| | 100 mg/1 mL | 100 pcs(5 pcs) | 5010-61341 |
| | 200 mg/3 mL | 50 pcs(5 pcs) | 5010-61342 |
| | 500 mg/3 mL | 50 pcs(1 pc) | 5010-61343 |
| | 500 mg/6 mL | 30 pcs(1 pc) | 5010-61344 |
| | 1 g/6 mL | 30 pcs(1 pc) | 5010-61345 |
| | 2 g/12 mL | 20 pcs(1 pc) | 5010-61346 |
| | 5 g/20 mL | 20 pcs(1 pc) | 5010-61347 |
| | 10 g/60 mL | 16 pcs(1 pc) | 5010-61348 |
| | 20 g/60 mL | 16 pcs(1 pc) | 5010-61349 |
| | 25 g/150 mL | 8 pcs(1 pc) | 5010-61350 |
| | 50 g/150 mL | 8 pcs(1 pc) | 5010-61351 |
| 70 g/150 mL | 8 pcs(1 pc) | 5010-61352 | |

Large-Size Cartridges (LSC)

| Description | Bed Weight/Volume | Qty.(pk unit) | Cat.No. |
|-----------------|-------------------|---------------|------------|
| InertSep LSC SI | 100 mg | 50 pcs(1 pc) | 5010-63341 |
| | 200 mg | 50 pcs(1 pc) | 5010-63342 |
| | 500 mg | 50 pcs(1 pc) | 5010-63343 |

Luer-Device Cartridges

| Description | Bed Weight/Volume | Qty.(pk unit) | Cat.No. |
|--------------------|-------------------|---------------|------------|
| InertSep Slim-J SI | 500 mg | 50 pcs(5 pcs) | 5010-65340 |
| | 1000 mg | 50 pcs(5 pcs) | 5010-65341 |
| InertSep Slim SI | 690 mg | 50 pcs(5 pcs) | 5010-65345 |

96-Well Plates

| Description | Bed Weight/Volume | Qty. | Cat.No. |
|------------------|-------------------|------|------------|
| InertSep 96WP SI | 50 mg | 1 pc | 5010-66320 |
| | 100 mg | 1 pc | 5010-66321 |

Bulk Material

| Description | Volume | Cat.No. |
|-------------|--------|------------|
| InertSep SI | 100 g | 5010-69011 |

Silica-Based SPE (Polar)

InertSep SI FF

Si-OH

Average Particle Size : 120 µm
 Surface Area : 450 m²/g
 Pore Volume : 0.7 mL/g
 Pore Size : 6 nm
 pH Range : 2-8

InertSep SI FF is an arranged version of InertSep SI for applications that need high flow late. This sorbent is also good at viscous sample and large volume sample to expedite the procedure.

Syringe-Barrel Cartridges

| Description | Bed Weight/Volume | Qty.(pk unit) | Cat.No. |
|----------------|-------------------|----------------|------------|
| InertSep SI FF | 50 mg/1 mL | 100 pcs(5 pcs) | 5010-62340 |
| | 100 mg/1 mL | 100 pcs(5 pcs) | 5010-62341 |
| | 200 mg/3 mL | 50 pcs(5 pcs) | 5010-62342 |
| | 500 mg/3 mL | 50 pcs(1 pc) | 5010-62343 |
| | 500 mg/6 mL | 30 pcs(1 pc) | 5010-62344 |
| | 1 g/6 mL | 30 pcs(1 pc) | 5010-62345 |
| | 2 g/12 mL | 20 pcs(1 pc) | 5010-62346 |
| | 5 g/20 mL | 20 pcs(1 pc) | 5010-62347 |
| | 10 g/60 mL | 16 pcs(1 pc) | 5010-62348 |
| | 20 g/60 mL | 16 pcs(1 pc) | 5010-62349 |
| | 25 g/150 mL | 8 pcs(1 pc) | 5010-62350 |
| | 50 g/150 mL | 8 pcs(1 pc) | 5010-62351 |
| 70 g/150 mL | 8 pcs(1 pc) | 5010-62352 | |

Large-Size Cartridges (LSC)

| Description | Bed Weight/Volume | Qty.(pk unit) | Cat.No. |
|--------------------|-------------------|---------------|------------|
| InertSep LSC SI FF | 100 mg | 50 pcs(1 pc) | 5010-64341 |
| | 200 mg | 50 pcs(1 pc) | 5010-64342 |
| | 500 mg | 50 pcs(1 pc) | 5010-64343 |

Bulk Material

| Description | Volume | Cat.No. |
|----------------|--------|------------|
| InertSep SI FF | 100 g | 5010-69030 |

Silica-Based SPE (Polar)

InertSep AL-A

Al₂O₃

Average Particle Size : 100 μm
 Surface Area : 130 m²/g
 Pore Volume : 0.3 mL/g
 Pore Size : 8 nm
 pH Range : 3.5-5.0(acid)

InertSep AL-A is packed with alumina (Al₂O₃). Available in Al₂O₃ acidic format.

Syringe-Barrel Cartridges

| Description | Bed Weight/Volume | Qty.(pk unit) | Cat.No. |
|---------------|-------------------|----------------|------------|
| InertSep AL-A | 50 mg/1 mL | 100 pcs(5 pcs) | 5010-61360 |
| | 100 mg/1 mL | 100 pcs(5 pcs) | 5010-61361 |
| | 200 mg/3 mL | 50 pcs(5 pcs) | 5010-61362 |
| | 500 mg/3 mL | 50 pcs(1 pc) | 5010-61363 |
| | 500 mg/6 mL | 30 pcs(1 pc) | 5010-61364 |
| | 1 g/6 mL | 30 pcs(1 pc) | 5010-61365 |
| | 2 g/12 mL | 20 pcs(1 pc) | 5010-61366 |
| | 5 g/20 mL | 20 pcs(1 pc) | 5010-61367 |
| | 10 g/60 mL | 16 pcs(1 pc) | 5010-61368 |

Large-Size Cartridges (LSC)

| Description | Bed Weight/Volume | Qty.(pk unit) | Cat.No. |
|-------------------|-------------------|---------------|------------|
| InertSep LSC AL-A | 100 mg | 50 pcs(1 pc) | 5010-63361 |
| | 200 mg | 50 pcs(1 pc) | 5010-63362 |
| | 500 mg | 50 pcs(1 pc) | 5010-63363 |

Luer-Device Cartridges

| Description | Bed Weight/Volume | Qty.(pk unit) | Cat.No. |
|----------------------|-------------------|---------------|------------|
| InertSep Slim-J AL-A | 500 mg | 50 pcs(5 pcs) | 5010-65360 |
| | 1000 mg | 50 pcs(5 pcs) | 5010-65361 |
| | 1710 mg | 50 pcs(5 pcs) | 5010-65362 |

Bulk Material

| Description | Volume | Cat.No. |
|---------------|--------|------------|
| InertSep AL-A | 100 g | 5010-69012 |

1

InertSep Series

Silica-Based SPE (Polar)

InertSep AL-N

Al₂O₃

Average Particle Size : 100 μm
 Surface Area : 130 m²/g
 Pore Volume : 0.3 mL/g
 Pore Size : 8 nm
 pH Range : 6.0-7.5 (neutral)

InertSep AL-N is packed with alumina (Al₂O₃). Available in Al₂O₃ neutral format.

Syringe-Barrel Cartridges

| Description | Bed Weight/Volume | Qty.(pk unit) | Cat.No. |
|---------------|-------------------|----------------|------------|
| InertSep AL-N | 50 mg/1 mL | 100 pcs(5 pcs) | 5010-61400 |
| | 100 mg/1 mL | 100 pcs(5 pcs) | 5010-61401 |
| | 200 mg/3 mL | 50 pcs(5 pcs) | 5010-61402 |
| | 500 mg/3 mL | 50 pcs(1 pc) | 5010-61403 |
| | 500 mg/6 mL | 30 pcs(1 pc) | 5010-61404 |
| | 1 g/6 mL | 30 pcs(1 pc) | 5010-61405 |
| | 2 g/12 mL | 20 pcs(1 pc) | 5010-61406 |
| | 5 g/20 mL | 20 pcs(1 pc) | 5010-61407 |
| | 10 g/60 mL | 16 pcs(1 pc) | 5010-61408 |

Large-Size Cartridges (LSC)

| Description | Bed Weight/Volume | Qty.(pk unit) | Cat.No. |
|-------------------|-------------------|---------------|------------|
| InertSep LSC AL-N | 100 mg | 50 pcs(1 pc) | 5010-63401 |
| | 200 mg | 50 pcs(1 pc) | 5010-63402 |
| | 500 mg | 50 pcs(1 pc) | 5010-63403 |

Luer-Device Cartridges

| Description | Bed Weight/Volume | Qty.(pk unit) | Cat.No. |
|----------------------|-------------------|---------------|------------|
| InertSep Slim-J AL-N | 500 mg | 50 pcs(5 pcs) | 5010-65400 |
| | 1000 mg | 50 pcs(5 pcs) | 5010-65401 |
| | 1710 mg | 50 pcs(5 pcs) | 5010-65402 |
| | 1850 mg | 50 pcs(5 pcs) | 5010-65403 |

Bulk Material

| Description | Volume | Cat.No. |
|---------------|--------|------------|
| InertSep AL-N | 100 g | 5010-69014 |

Silica-Based SPE (Polar)

InertSep AL-B

Al₂O₃

Average Particle Size : 100 µm
 Surface Area : 130 m²/g
 Pore Volume : 0.3 mL/g
 Pore Size : 8 nm
 pH : 9.0-10.5(basic)

InertSep AL-B is packed with alumina (Al₂O₃). Available in Al₂O₃ basic format.

Syringe-Barrel Cartridges

| Description | Bed Weight/Volume | Qty.(pk unit) | Cat.No. |
|---------------|-------------------|----------------|------------|
| InertSep AL-B | 50 mg/1 mL | 100 pcs(5 pcs) | 5010-61380 |
| | 100 mg/1 mL | 100 pcs(5 pcs) | 5010-61381 |
| | 200 mg/3 mL | 50 pcs(5 pcs) | 5010-61382 |
| | 500 mg/3 mL | 50 pcs(1 pc) | 5010-61383 |
| | 500 mg/6 mL | 30 pcs(1 pc) | 5010-61384 |
| | 1 g/6 mL | 30 pcs(1 pc) | 5010-61385 |
| | 2 g/12 mL | 20 pcs(1 pc) | 5010-61386 |
| | 5 g/20 mL | 20 pcs(1 pc) | 5010-61387 |
| | 10 g/60 mL | 16 pcs(1 pc) | 5010-61388 |

Large-Size Cartridges (LSC)

| Description | Bed Weight/Volume | Qty.(pk unit) | Cat.No. |
|-------------------|-------------------|---------------|------------|
| InertSep LSC AL-B | 100 mg | 50 pcs(1 pc) | 5010-63381 |
| | 200 mg | 50 pcs(1 pc) | 5010-63382 |
| | 500 mg | 50 pcs(1 pc) | 5010-63383 |

Luer-Device Cartridges

| Description | Bed Weight/Volume | Qty.(pk unit) | Cat.No. |
|----------------------|-------------------|---------------|------------|
| InertSep Slim-J AL-B | 500 mg | 50 pcs(5 pcs) | 5010-65380 |
| | 1000 mg | 50 pcs(5 pcs) | 5010-65381 |
| | 1710 mg | 50 pcs(5 pcs) | 5010-65382 |

Bulk Material

| Description | Volume | Cat.No. |
|---------------|--------|------------|
| InertSep AL-B | 100 g | 5010-69013 |

1

InertSep Series

InertSep FL(Synthetic Magnesium Silicate)



Average Particle Size : 50-200 μm
 Surface Area : 230 m^2/g
 Pore Volume : 0.5 mL/g
 Pore Size : 9 nm

InertSep FL is packed with synthetic magnesium silicate. This sorbent strongly adsorbs polar compounds from none polar matrices and is typically used for sample cleanup of organic extracts.

Syringe-Barrel Cartridges

| Description | Bed Weight/Volume | Qty.(pk unit) | Cat.No. |
|-------------|-------------------|----------------|------------|
| InertSep FL | 50 mg/1 mL | 100 pcs(5 pcs) | 5010-61420 |
| | 100 mg/1 mL | 100 pcs(5 pcs) | 5010-61421 |
| | 200 mg/3 mL | 50 pcs(5 pcs) | 5010-61422 |
| | 500 mg/3 mL | 50 pcs(1 pc) | 5010-61423 |
| | 500 mg/6 mL | 30 pcs(1 pc) | 5010-61424 |
| | 1 g/6 mL | 30 pcs(1 pc) | 5010-61425 |
| | 2 g/12 mL | 20 pcs(1 pc) | 5010-61426 |
| | 5 g/20 mL | 20 pcs(1 pc) | 5010-61427 |
| | 10 g/60 mL | 16 pcs(1 pc) | 5010-61428 |

Large-Size Cartridges (LSC)

| Description | Bed Weight/Volume | Qty.(pk unit) | Cat.No. |
|-----------------|-------------------|---------------|------------|
| InertSep LSC FL | 100 mg | 50 pcs(1 pc) | 5010-63421 |
| | 200 mg | 50 pcs(1 pc) | 5010-63422 |
| | 500 mg | 50 pcs(1 pc) | 5010-63423 |

Luer-Device Cartridges

| Description | Bed Weight/Volume | Qty.(pk unit) | Cat.No. |
|--------------------|-------------------|---------------|------------|
| InertSep Slim-J FL | 500 mg | 50 pcs(5 pcs) | 5010-65420 |
| | 900 mg | 50 pcs(5 pcs) | 5010-65422 |
| | 1000 mg | 50 pcs(5 pcs) | 5010-65421 |

Bulk Material

| Description | Volume | Cat.No. |
|-------------|--------|------------|
| InertSep FL | 100 g | 5010-69015 |

InertSep FL-PR(Synthetic Magnesium Silicate)



Average Particle Size : 100-300 μm
 Surface Area : 230 m^2/g
 Pore Volume : 0.5 mL/g
 Pore Size : 9 nm

InertSep FL-PR cartridges are packed with FL-PR, which is used for sample cleanup for analysis of residual pesticides in crops. This sorbent is also suitable for viscous samples and large volume samples to increase the throughput.

Syringe-Barrel Cartridges

| Description | Bed Weight/Volume | Qty.(pk unit) | Cat.No. |
|----------------|-------------------|----------------|------------|
| InertSep FL-PR | 50 mg/1 mL | 100 pcs(5 pcs) | 5010-61440 |
| | 100 mg/1 mL | 100 pcs(5 pcs) | 5010-61441 |
| | 200 mg/3 mL | 50 pcs(5 pcs) | 5010-61442 |
| | 500 mg/3 mL | 50 pcs(1 pc) | 5010-61443 |
| | 500 mg/6 mL | 30 pcs(1 pc) | 5010-61444 |
| | 910 mg/20 mL | 20 pcs(1 pc) | 5010-61453 |
| | 1 g/6 mL | 30 pcs(1 pc) | 5010-61445 |
| | 2 g/12 mL | 20 pcs(1 pc) | 5010-61446 |
| | 5 g/20 mL | 20 pcs(1 pc) | 5010-61447 |
| | 10 g/60 mL | 16 pcs(1 pc) | 5010-61448 |

Large-Size Cartridges (LSC)

| Description | Bed Weight/Volume | Qty.(pk unit) | Cat.No. |
|--------------------|-------------------|---------------|------------|
| InertSep LSC FL-PR | 100 mg | 50 pcs(1 pc) | 5010-63441 |
| | 200 mg | 50 pcs(1 pc) | 5010-63442 |
| | 500 mg | 50 pcs(1 pc) | 5010-63443 |

Luer-Device Cartridges

| Description | Bed Weight/Volume | Qty.(pk unit) | Cat.No. |
|-----------------------|-------------------|---------------|------------|
| InertSep Slim-J FL-PR | 500 mg | 50 pcs(5 pcs) | 5010-65440 |
| | 900 mg | 50 pcs(5 pcs) | 5010-65442 |
| | 1000 mg | 50 pcs(5 pcs) | 5010-65441 |

Bulk Material

| Description | Volume | Cat.No. |
|----------------|--------|------------|
| InertSep FL-PR | 100 g | 5010-69016 |

Silica-Based SPE (Ion Exchange)

InertSep CBA

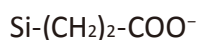

| | |
|-----------------------|---------------------------|
| Average Particle Size | : 45 µm |
| Carbon Load | : 8.5 % |
| Surface Area | : 450 m ² /g |
| Pore Volume | : 0.7 mL/g |
| Pore Size | : 6 nm |
| Ion exchange capacity | : 1.2 meq/g |
| pH Range | : 2-8 |
| Remark | : H ⁺ ion pair |

InertSep CBA is a silica-based sorbent modified with carboxylethyl functional groups. The primary interactions of this sorbent are cation exchange and the secondary interactions are weak-polar and non-polar. This sorbent is suitable for extraction of drugs with strongly cationic amine groups.

Syringe-Barrel Cartridges

| Description | Bed Weight/Volume | Qty.(pk unit) | Cat.No. |
|--------------|-------------------|----------------|------------|
| InertSep CBA | 50 mg/1 mL | 100 pcs(5 pcs) | 5010-61500 |
| | 100 mg/1 mL | 100 pcs(5 pcs) | 5010-61501 |
| | 100 mg/3 mL | 50 pcs(5 pcs) | 5010-61511 |
| | 200 mg/3 mL | 50 pcs(5 pcs) | 5010-61502 |
| | 250 mg/3 mL | 50 pcs(1 pc) | 5010-61509 |
| | 500 mg/3 mL | 50 pcs(1 pc) | 5010-61503 |
| | 250 mg/6 mL | 30 pcs(1 pc) | 5010-61510 |
| | 500 mg/6 mL | 30 pcs(1 pc) | 5010-61504 |
| | 1 g/6 mL | 30 pcs(1 pc) | 5010-61505 |
| | 2 g/12 mL | 20 pcs(1 pc) | 5010-61506 |
| | 5 g/20 mL | 20 pcs(1 pc) | 5010-61507 |
| | 10 g/60 mL | 16 pcs(1 pc) | 5010-61508 |

Large-Size Cartridges (LSC)

| Description | Bed Weight/Volume | Qty.(pk unit) | Cat.No. |
|------------------|-------------------|---------------|------------|
| InertSep LSC CBA | 100 mg | 50 pcs(1 pc) | 5010-63501 |
| | 200 mg | 50 pcs(1 pc) | 5010-63502 |
| | 500 mg | 50 pcs(1 pc) | 5010-63503 |

Luer-Device Cartridges

| Description | Bed Weight/Volume | Qty.(pk unit) | Cat.No. |
|---------------------|-------------------|---------------|------------|
| InertSep Slim-J CBA | 500 mg | 50 pcs(5 pcs) | 5010-65500 |
| | 1000 mg | 50 pcs(5 pcs) | 5010-65501 |

96-Well Plates

| Description | Bed Weight/Volume | Qty. | Cat.No. |
|-------------------|-------------------|------|------------|
| InertSep 96WP CBA | 50 mg | 1 pc | 5010-66400 |
| | 100 mg | 1 pc | 5010-66401 |

Bulk Material

| Description | Volume | Cat.No. |
|--------------|--------|------------|
| InertSep CBA | 100 g | 5010-69017 |

Silica-Based SPE (Ion Exchange)

1

InertSep Series

InertSep PRS

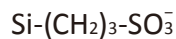

| | |
|-----------------------|---------------------------|
| Average Particle Size | : 45 μm |
| Carbon Load | : 8.5 % |
| Surface Area | : 450 m ² /g |
| Pore Volume | : 0.7 mL/g |
| Pore Size | : 6 nm |
| Ion exchange capacity | : 1.2 meq/g |
| pH Range | : 2-8 |
| Remark | : H ⁺ ion pair |

InertSep PRS is a silica-based sorbent modified with sulfonylpropyl groups. The primary interactions of this sorbent are anion exchange and secondary interactions are slightly non-polar.

Syringe-Barrel Cartridges

| Description | Bed Weight/Volume | Qty.(pk unit) | Cat.No. |
|--------------|-------------------|----------------|------------|
| InertSep PRS | 50 mg/1 mL | 100 pcs(5 pcs) | 5010-61520 |
| | 100 mg/1 mL | 100 pcs(5 pcs) | 5010-61521 |
| | 200 mg/3 mL | 50 pcs(5 pcs) | 5010-61522 |
| | 500 mg/3 mL | 50 pcs(1 pc) | 5010-61523 |
| | 500 mg/6 mL | 30 pcs(1 pc) | 5010-61524 |
| | 1 g/6 mL | 30 pcs(1 pc) | 5010-61525 |
| | 2 g/12 mL | 20 pcs(1 pc) | 5010-61526 |
| | 500 mg/20 mL | 20 pcs | 5010-61529 |
| | 5 g/20 mL | 20 pcs(1 pc) | 5010-61527 |
| | 10 g/60 mL | 16 pcs(1 pc) | 5010-61528 |

Large-Size Cartridges (LSC)

| Description | Bed Weight/Volume | Qty.(pk unit) | Cat.No. |
|------------------|-------------------|---------------|------------|
| InertSep LSC PRS | 100 mg | 50 pcs(1 pc) | 5010-63521 |
| | 200 mg | 50 pcs(1 pc) | 5010-63522 |
| | 500 mg | 50 pcs(1 pc) | 5010-63523 |

Luer-Device Cartridges

| Description | Bed Weight/Volume | Qty.(pk unit) | Cat.No. |
|---------------------|-------------------|---------------|------------|
| InertSep Slim-J PRS | 500 mg | 50 pcs(5 pcs) | 5010-65520 |
| | 1000 mg | 50 pcs(5 pcs) | 5010-65521 |

96-Well Plates

| Description | Bed Weight/Volume | Qty. | Cat.No. |
|-------------------|-------------------|------|------------|
| InertSep 96WP PRS | 50 mg | 1 pc | 5010-66410 |
| | 100 mg | 1 pc | 5010-66411 |

Bulk Material

| Description | Volume | Cat.No. |
|--------------|--------|------------|
| InertSep PRS | 100 g | 5010-69018 |

Silica-Based SPE (Ion Exchange)

1

InertSep Series

InertSep SCX

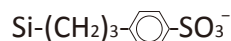

| | |
|-----------------------|---------------------------|
| Average Particle Size | : 45 µm |
| Carbon Load | : 8.5 % |
| Surface Area | : 450 m ² /g |
| Pore Volume | : 0.7 mL/g |
| Pore Size | : 6 nm |
| Ion exchange capacity | : 0.6 meq/g |
| pH Range | : 2-8 |
| Remark | : H ⁺ ion pair |

InertSep SCX is a silica-based sorbent modified with propylbenzenesulfonyl groups. The primary interactions of this sorbent are both non-polar and strong cation exchange. Because the non-polar interactions on InertSep SCX is stronger than those on InertSep PRS, it is suitable for extractions which require both non-polar interactions and strong cation exchange.

Syringe-Barrel Cartridges

| Description | Bed Weight/Volume | Qty.(pk unit) | Cat.No. |
|--------------|-------------------|----------------|------------|
| InertSep SCX | 50 mg/1 mL | 100 pcs(5 pcs) | 5010-61540 |
| | 100 mg/1 mL | 100 pcs(5 pcs) | 5010-61541 |
| | 200 mg/3 mL | 50 pcs(5 pcs) | 5010-61542 |
| | 500 mg/3 mL | 50 pcs(1 pc) | 5010-61543 |
| | 500 mg/6 mL | 30 pcs(1 pc) | 5010-61544 |
| | 500 mg/20 mL | 20 pcs(1 pc) | 5010-61553 |
| | 1 g/6 mL | 30 pcs(1 pc) | 5010-61545 |
| | 2 g/12 mL | 20 pcs(1 pc) | 5010-61546 |
| | 5 g/20 mL | 20 pcs(1 pc) | 5010-61547 |
| | 10 g/60 mL | 16 pcs(1 pc) | 5010-61548 |
| | 20 g/60 mL | 16 pcs(1 pc) | 5010-61549 |
| | 25 g/150 mL | 8 pcs(1 pc) | 5010-61550 |
| | 50 g/150 mL | 8 pcs(1 pc) | 5010-61551 |
| 70 g/150 mL | 8 pcs(1 pc) | 5010-61552 | |

Large-Size Cartridges (LSC)

| Description | Bed Weight/Volume | Qty.(pk unit) | Cat.No. |
|------------------|-------------------|---------------|------------|
| InertSep LSC SCX | 100 mg | 50 pcs(1 pc) | 5010-63541 |
| | 200 mg | 50 pcs(1 pc) | 5010-63542 |
| | 500 mg | 50 pcs(1 pc) | 5010-63543 |

Luer-Device Cartridges

| Description | Bed Weight/Volume | Qty.(pk unit) | Cat.No. |
|---------------------|-------------------|---------------|------------|
| InertSep Slim-J SCX | 500 mg | 50 pcs(5 pcs) | 5010-65540 |
| | 1000 mg | 50 pcs(5 pcs) | 5010-65541 |

96-Well Plates

| Description | Bed Weight/Volume | Qty. | Cat.No. |
|-------------------|-------------------|------|------------|
| InertSep 96WP SCX | 50 mg | 1 pc | 5010-66420 |
| | 100 mg | 1 pc | 5010-66421 |

Bulk Material

| Description | Volume | Cat.No. |
|--------------|--------|------------|
| InertSep SCX | 100 g | 5010-69019 |

Silica-Based SPE (Ion Exchange)

1

InertSep Series

InertSep SCX-2

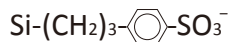

| | |
|-----------------------|---------------------------|
| Average Particle Size | : 60 μm |
| Carbon Load | : 17 % |
| Surface Area | : 450 m ² /g |
| Pore Volume | : 0.7 mL/g |
| Pore Size | : 6 nm |
| Ion exchange capacity | : 1.2 meq/g |
| pH Range | : 2-8 |
| Remark | : H ⁺ ion pair |

InertSep SCX-2 employs the same chemical modification with InertSep SCX. The only difference is that propylbenzenesulfonyl groups are bonded more densely on the silica surface to increase ion exchange capacity and retentivity.

Syringe-Barrel Cartridges

| Description | Bed Weight/Volume | Qty.(pk unit) | Cat.No. |
|----------------|-------------------|----------------|------------|
| InertSep SCX-2 | 50 mg/1 mL | 100 pcs(5 pcs) | 5010-61720 |
| | 100 mg/1 mL | 100 pcs(5 pcs) | 5010-61721 |
| | 200 mg/3 mL | 50 pcs(5 pcs) | 5010-61722 |
| | 500 mg/3 mL | 50 pcs(1 pc) | 5010-61723 |
| | 500 mg/6 mL | 30 pcs(1 pc) | 5010-61724 |
| | 500 mg/20 mL | 20 pcs(1 pc) | 5010-61733 |
| | 1 g/6 mL | 30 pcs(1 pc) | 5010-61725 |
| | 2 g/12 mL | 20 pcs(1 pc) | 5010-61726 |
| | 5 g/20 mL | 20 pcs(1 pc) | 5010-61727 |
| | 10 g/60 mL | 16 pcs(1 pc) | 5010-61728 |
| | 20 g/60 mL | 16 pcs(1 pc) | 5010-61729 |
| | 25 g/150 mL | 8 pcs(1 pc) | 5010-61730 |
| | 50 g/150 mL | 8 pcs(1 pc) | 5010-61731 |
| 70 g/150 mL | 8 pcs(1 pc) | 5010-61732 | |

Large-Size Cartridges (LSC)

| Description | Bed Weight/Volume | Qty.(pk unit) | Cat.No. |
|--------------------|-------------------|---------------|------------|
| InertSep LSC SCX-2 | 100 mg | 50 pcs(1 pc) | 5010-63661 |
| | 200 mg | 50 pcs(1 pc) | 5010-63662 |
| | 500 mg | 50 pcs(1 pc) | 5010-63663 |

Luer-Device Cartridges

| Description | Bed Weight/Volume | Qty.(pk unit) | Cat.No. |
|-----------------------|-------------------|---------------|------------|
| InertSep Slim-J SCX-2 | 500 mg | 50 pcs(5 pcs) | 5010-65660 |
| | 1000 mg | 50 pcs(5 pcs) | 5010-65661 |

96-Well Plates

| Description | Bed Weight/Volume | Qty. | Cat.No. |
|----------------|-------------------|------|------------|
| InertSep SCX-2 | 50 mg | 1 pc | 5010-66430 |
| | 100 mg | 1 pc | 5010-66431 |

Bulk Material

| Description | Volume | Cat.No. |
|----------------|--------|------------|
| InertSep SCX-2 | 100 g | 5010-69034 |

Silica-Based SPE (Ion Exchange)

InertSep NH2

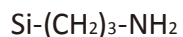

| | |
|-----------------------|-------------------------|
| Average Particle Size | : 60 μm |
| Carbon Load | : 10 % |
| Surface Area | : 450 m ² /g |
| Pore Volume | : 0.7 mL/g |
| Pore Size | : 6 nm |
| Ion exchange capacity | : 0.9 meq/g |
| pH Range | : 2-8 |

InertSep NH2 is a silica-based sorbent modified with an aminopropyl groups. Anion exchange and polar interaction are combined as the primary interactions. As the secondary interactions, it has weak non-polar interactions. Similar to InertSep 2OH and InertSep SI used in normal phase mode, InertSep NH2 can be used for the separation of structural isomers.

Syringe-Barrel Cartridges

| Description | Bed Weight/Volume | Qty.(pk unit) | Cat.No. |
|--------------|-------------------|----------------|------------|
| InertSep NH2 | 50 mg/1 mL | 100 pcs(5 pcs) | 5010-61600 |
| | 100 mg/1 mL | 100 pcs(5 pcs) | 5010-61601 |
| | 200 mg/3 mL | 50 pcs(5 pcs) | 5010-61602 |
| | 500 mg/3 mL | 50 pcs(1 pc) | 5010-61603 |
| | 500 mg/6 mL | 30 pcs(1 pc) | 5010-61604 |
| | 1 g/6 mL | 30 pcs(1 pc) | 5010-61605 |
| | 2 g/12 mL | 20 pcs(1 pc) | 5010-61606 |
| | 5 g/20 mL | 20 pcs(1 pc) | 5010-61607 |
| | 10 g/60 mL | 16 pcs(1 pc) | 5010-61608 |
| | 20 g/60 mL | 16 pcs(1 pc) | 5010-61609 |
| | 25 g/150 mL | 8 pcs(1 pc) | 5010-61610 |
| | 50 g/150 mL | 8 pcs(1 pc) | 5010-61611 |
| | 70 g/150 mL | 8 pcs(1 pc) | 5010-61612 |

Large-Size Cartridges (LSC)

| Description | Bed Weight/Volume | Qty.(pk unit) | Cat.No. |
|------------------|-------------------|---------------|------------|
| InertSep LSC NH2 | 100 mg | 50 pcs(1 pc) | 5010-63601 |
| | 200 mg | 50 pcs(1 pc) | 5010-63602 |
| | 500 mg | 50 pcs(1 pc) | 5010-63603 |

Luer-Device Cartridges

| Description | Bed Weight/Volume | Qty.(pk unit) | Cat.No. |
|---------------------|-------------------|---------------|------------|
| InertSep Slim-J NH2 | 500 mg | 50 pcs(5 pcs) | 5010-65600 |
| | 1000 mg | 50 pcs(5 pcs) | 5010-65601 |
| InertSep Slim NH2 | 360 mg | 50 pcs(5 pcs) | 5010-65605 |

96-Well Plates

| Description | Bed Weight/Volume | Qty. | Cat.No. |
|-------------------|-------------------|------|------------|
| InertSep 96WP NH2 | 50 mg | 1 pc | 5010-66600 |
| | 100 mg | 1 pc | 5010-66601 |

Bulk Material

| Description | Volume | Cat.No. |
|--------------|--------|------------|
| InertSep NH2 | 100 g | 5010-69020 |

InertSep NH2 FF

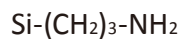

| | |
|-----------------------|-------------------------|
| Average Particle Size | : 120 μm |
| Carbon Load | : 10 % |
| Surface Area | : 450 m ² /g |
| Pore Volume | : 0.7 mL/g |
| Pore Size | : 6 nm |
| Ion exchange capacity | : 0.9 meq/g |
| pH Range | : 2-8 |

InertSep NH2 FF is a modified version of InertSep NH2 for high flow lates. This sorbent is also suitable for viscous samples and large volume samples to increase the throughput.

Syringe-Barrel Cartridges

| Description | Bed Weight/Volume | Qty.(pk unit) | Cat.No. |
|-----------------|-------------------|----------------|------------|
| InertSep NH2 FF | 50 mg/1 mL | 100 pcs(5 pcs) | 5010-62600 |
| | 100 mg/1 mL | 100 pcs(5 pcs) | 5010-62601 |
| | 200 mg/3 mL | 50 pcs(5 pcs) | 5010-62602 |
| | 500 mg/3 mL | 50 pcs(1 pc) | 5010-62603 |
| | 500 mg/6 mL | 30 pcs(1 pc) | 5010-62604 |
| | 1 g/6 mL | 30 pcs(1 pc) | 5010-62605 |
| | 2 g/12 mL | 20 pcs(1 pc) | 5010-62606 |
| | 5 g/20 mL | 20 pcs(1 pc) | 5010-62607 |
| | 10 g/60 mL | 16 pcs(1 pc) | 5010-62608 |
| | 20 g/60 mL | 16 pcs(1 pc) | 5010-62609 |
| | 25 g/150 mL | 8 pcs(1 pc) | 5010-62610 |
| | 50 g/150 mL | 8 pcs(1 pc) | 5010-62611 |
| 70 g/150 mL | 8 pcs(1 pc) | 5010-62612 | |

Large-Size Cartridges (LSC)

| Description | Bed Weight/Volume | Qty.(pk unit) | Cat.No. |
|---------------------|-------------------|---------------|------------|
| InertSep LSC NH2 FF | 100 mg | 50 pcs(1 pc) | 5010-64601 |
| | 200 mg | 50 pcs(1 pc) | 5010-64602 |
| | 500 mg | 50 pcs(1 pc) | 5010-64603 |

Bulk Material

| Description | Volume | Cat.No. |
|-----------------|--------|------------|
| InertSep NH2 FF | 100 g | 5010-69031 |

Silica-Based SPE (Ion Exchange)

InertSep PSA

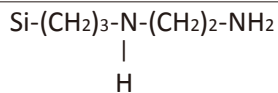

Average Particle Size : 60 μm
 Carbon Load : 11.5 %
 Surface Area : 450 m²/g
 Pore Volume : 0.7 mL/g
 Pore Size : 6 nm
 Ion exchange capacity : 1.5 meq/g
 pH Range : 2-8

InertSep PSA is a silica-based sorbent modified with ethylene-diamine-Npropyl groups. The primary interactions of this sorbent are anion exchange and secondary interactions are weak non-polar.

Syringe-Barrel Cartridges

| Description | Bed Weight/Volume | Qty.(pk unit) | Cat.No. |
|--------------|-------------------|----------------|------------|
| InertSep PSA | 50 mg/1 mL | 100 pcs(5 pcs) | 5010-61620 |
| | 100 mg/1 mL | 100 pcs(5 pcs) | 5010-61621 |
| | 200 mg/3 mL | 50 pcs(5 pcs) | 5010-61622 |
| | 500 mg/3 mL | 50 pcs(1 pc) | 5010-61623 |
| | 500 mg/6 mL | 30 pcs(1 pc) | 5010-61624 |
| | 500 mg/20 mL | 20 pcs(1 pc) | 5010-61629 |
| | 1 g/6 mL | 30 pcs(1 pc) | 5010-61625 |
| | 2 g/12 mL | 20 pcs(1 pc) | 5010-61626 |
| | 5 g/20 mL | 20 pcs(1 pc) | 5010-61627 |
| | 10 g/60 mL | 16 pcs(1 pc) | 5010-61628 |

Large-Size Cartridges (LSC)

| Description | Bed Weight/Volume | Qty.(pk unit) | Cat.No. |
|------------------|-------------------|---------------|------------|
| InertSep LSC PSA | 100 mg | 50 pcs(1 pc) | 5010-63621 |
| | 200 mg | 50 pcs(1 pc) | 5010-63622 |
| | 500 mg | 50 pcs(1 pc) | 5010-63623 |

Luer-Device Cartridges

| Description | Bed Weight/Volume | Qty.(pk unit) | Cat.No. |
|---------------------|-------------------|---------------|------------|
| InertSep Slim-J PSA | 500 mg | 50 pcs(5 pcs) | 5010-65620 |
| | 1000 mg | 50 pcs(5 pcs) | 5010-65621 |

96-Well Plates

| Description | Bed Weight/Volume | Qty. | Cat.No. |
|-------------------|-------------------|------|------------|
| InertSep 96WP PSA | 50 mg | 1 pc | 5010-66610 |
| | 100 mg | 1 pc | 5010-66611 |

Bulk Material

| Description | Volume | Cat.No. |
|--------------|--------|------------|
| InertSep PSA | 100 g | 5010-69021 |

Silica-Based SPE (Ion Exchange)

InertSep SAX

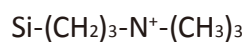

| | |
|-----------------------|----------------------------|
| Average Particle Size | : 45 μm |
| Carbon Load | : 7 % |
| Surface Area | : 450 m ² /g |
| Pore Volume | : 0.7 mL/g |
| Pore Size | : 6 nm |
| Ion exchange capacity | : 0.7 meq/g |
| pH Range | : 2-8 |
| Remark | : OH ⁻ ion pair |

InertSep SAX is a silica-based sorbent modified with trimethylaminopropyl groups. Primary interactions are very strong anion exchange. Secondary interactions are non-polar. It is generally used for the extraction of weak anions such as carboxylic acids.

Syringe-Barrel Cartridges

| Description | Bed Weight/Volume | Qty.(pk unit) | Cat.No. |
|--------------|-------------------|----------------|------------|
| InertSep SAX | 50 mg/1 mL | 100 pcs(5 pcs) | 5010-61640 |
| | 100 mg/1 mL | 100 pcs(5 pcs) | 5010-61641 |
| | 150 mg/3 mL | 50 pcs(5 pcs) | 5010-61654 |
| | 200 mg/3 mL | 50 pcs(5 pcs) | 5010-61642 |
| | 360 mg/3 mL | 50 pcs(5 pcs) | 5010-61655 |
| | 500 mg/3 mL | 50 pcs(1 pc) | 5010-61643 |
| | 500 mg/6 mL | 30 pcs(1 pc) | 5010-61644 |
| | 1 g/6 mL | 30 pcs(1 pc) | 5010-61645 |
| | 2 g/12 mL | 20 pcs(1 pc) | 5010-61646 |
| | 5 g/20 mL | 20 pcs(1 pc) | 5010-61647 |
| | 10 g/60 mL | 16 pcs(1 pc) | 5010-61648 |
| | 20 g/60 mL | 16 pcs(1 pc) | 5010-61649 |
| | 25 g/150 mL | 8 pcs(1 pc) | 5010-61650 |
| | 50 g/150 mL | 8 pcs(1 pc) | 5010-61651 |
| | 70 g/150 mL | 8 pcs(1 pc) | 5010-61652 |

Large-Size Cartridges (LSC)

| Description | Bed Weight/Volume | Qty.(pk unit) | Cat.No. |
|------------------|-------------------|---------------|------------|
| InertSep LSC SAX | 100 mg | 50 pcs(1 pc) | 5010-63641 |
| | 200 mg | 50 pcs(1 pc) | 5010-63642 |
| | 500 mg | 50 pcs(1 pc) | 5010-63643 |

Luer-Device Cartridges

| Description | Bed Weight/Volume | Qty.(pk unit) | Cat.No. |
|---------------------|-------------------|---------------|------------|
| InertSep Slim-J SAX | 500 mg | 50 pcs(5 pcs) | 5010-65640 |
| | 1000 mg | 50 pcs(5 pcs) | 5010-65641 |

96-Well Plates

| Description | Bed Weight/Volume | Qty. | Cat.No. |
|-------------------|-------------------|------|------------|
| InertSep 96WP SAX | 50 mg | 1 pc | 5010-66620 |
| | 100 mg | 1 pc | 5010-66621 |

Bulk Material

| Description | Volume | Cat.No. |
|--------------|--------|------------|
| InertSep SAX | 100 g | 5010-69022 |

Silica-Based SPE (Ion Exchange)

1

InertSep Series

InertSep SAX-2

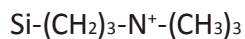

Average Particle Size : 60 μm
 Carbon Load : 11.5 %
 Surface Area : 450 m²/g
 Pore Volume : 0.7 mL/g
 Pore Size : 6 nm
 Ion exchange capacity : 0.45 meq/g
 pH Range : 2-8
 Remark : Cl⁻ ion pair

InertSep SAX-2 is a modified version of InertSep SAX for stronger non-polar interactions.

Syringe-Barrel Cartridges

| Description | Bed Weight/Volume | Qty.(pk unit) | Cat.No. |
|----------------|-------------------|----------------|------------|
| InertSep SAX-2 | 50 mg/1 mL | 100 pcs(5 pcs) | 5010-61700 |
| | 100 mg/1 mL | 100 pcs(5 pcs) | 5010-61701 |
| | 200 mg/3 mL | 50 pcs(5 pcs) | 5010-61702 |
| | 500 mg/3 mL | 50 pcs(1 pc) | 5010-61703 |
| | 500 mg/6 mL | 30 pcs(1 pc) | 5010-61704 |
| | 500 mg/20 mL | 20 pcs(1 pc) | 5010-61713 |
| | 1 g/6 mL | 30 pcs(1 pc) | 5010-61705 |
| | 2 g/12 mL | 20 pcs(1 pc) | 5010-61706 |
| | 5 g/20 mL | 20 pcs(1 pc) | 5010-61707 |
| | 10 g/60 mL | 16 pcs(1 pc) | 5010-61708 |
| | 20 g/60 mL | 16 pcs(1 pc) | 5010-61709 |
| | 25 g/150 mL | 8 pcs(1 pc) | 5010-61710 |
| | 50 g/150 mL | 8 pcs(1 pc) | 5010-61711 |
| | 70 g/150 mL | 8 pcs(1 pc) | 5010-61712 |

Large-Size Cartridges (LSC)

| Description | Bed Weight/Volume | Qty.(pk unit) | Cat.No. |
|--------------------|-------------------|---------------|------------|
| InertSep LSC SAX-2 | 100 mg | 50 pcs(1 pc) | 5010-63651 |
| | 200 mg | 50 pcs(1 pc) | 5010-63652 |
| | 500 mg | 50 pcs(1 pc) | 5010-63653 |

Luer-Device Cartridges

| Description | Bed Weight/Volume | Qty.(pk unit) | Cat.No. |
|-----------------------|-------------------|---------------|------------|
| InertSep Slim-J SAX-2 | 500 mg | 50 pcs(5 pcs) | 5010-65650 |
| | 1000 mg | 50 pcs(5 pcs) | 5010-65651 |

96-Well Plates

| Description | Bed Weight/Volume | Qty. | Cat.No. |
|---------------------|-------------------|------|------------|
| InertSep 96WP SAX-2 | 50 mg | 1 pc | 5010-66640 |
| | 100 mg | 1 pc | 5010-66641 |

Bulk Material

| Description | Volume | Cat.No. |
|----------------|--------|------------|
| InertSep SAX-2 | 100 g | 5010-69033 |

InertSep Slim-J AC (Active Carbon)



InertSep Slim-J AC

Base Gel : Active Carbon
 Average Particle Size : 60/150 mesh
 Surface Area : 800-1200 m²/g

InertSep Slim-J AC cartridges are packed with active carbon particles uniformly size classified for liquid permeability. As ultra-pure active carbon is employed, it is clear of worry about contamination. Good retentivity of this sorbent even for highly polar compounds ensure high recovery and reproducibility. Lure device format supports automation of SPE procedure.

| Description | Bed Weight/Volume | Qty. | Cat.No. |
|--------------------|-------------------|--------|------------|
| InertSep Slim-J AC | 400 mg | 50 pcs | 5010-25500 |

InertSep GC (Carbograph, Graphite Carbon)



InertSep GC

Base Gel : Graphite Carbon
 Average Particle Size : 120/400 mesh
 Surface Area : 85 m²/g
 Pore Volume : 1 mL/g
 Pore Size : 45 nm

InertSep GC cartridges are packed with graphite carbon in planar structure. They are generally used for removal of pigments from crop homogenates. In conjunction with other various normal phase sorbents and ion exchange sorbents, these cartridges are able to be used for a wide variety of applications as a cleanup sorbent.

Syringe-Barrel Cartridges

| Description | Bed Weight/Volume | Qty.(pk unit) | Cat.No. |
|-------------|-------------------|----------------|------------|
| InertSep GC | 100 mg/3 mL | 50 pcs(10 pcs) | 5010-68007 |
| | 150 mg/3 mL | 50 pcs(10 pcs) | 5010-68000 |
| | 250 mg/3 mL | 50 pcs(10 pcs) | 5010-68005 |
| | 300 mg/6 mL | 30 pcs(10 pcs) | 5010-68001 |
| | 500 mg/6 mL | 30 pcs(10 pcs) | 5010-68002 |
| | 1 g/12 mL | 20 pcs(10 pcs) | 5010-68003 |
| | 2 g/12 mL | 20 pcs(20 pcs) | 5010-68006 |
| | 500 mg/20 mL | 20 pcs(10 pcs) | 5010-68004 |

Luer-Device Cartridges

| Description | Bed Weight/Volume | Qty.(pk unit) | Cat.No. |
|------------------|-------------------|---------------|------------|
| InertSep Slim GC | 400 mg | 50 pcs(5 pcs) | 5010-65710 |

Bulk Material

| Description | Volume | Cat.No. |
|-------------|--------|------------|
| InertSep GC | 10 g | 5010-69050 |
| InertSep GC | 100 g | 5010-69051 |

InertSep GC/NH₂, GC/PSA

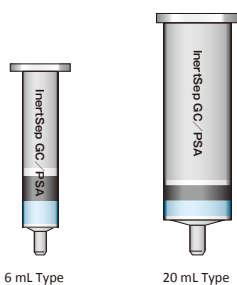

These two layer cartridges are packed with graphite carbon for removing pigments and NH₂ or PSA sorbent for sample cleanup of organic extracts. This consolidation of two layers achieves high sample cleanup performance which cannot be obtained only on one layer.

Two Layer Syringe-Barrel Type

| Description | Bed Weight/Volume | Qty.(pk unit) | Cat.No. |
|-----------------------------|---------------------|----------------|------------|
| InertSep GC/NH ₂ | 250 mg/250 mg/3 mL | 50 pcs(10 pcs) | 5010-68020 |
| | 500 mg/500 mg/6 mL | 30 pcs(10 pcs) | 5010-68022 |
| | 500 mg/500 mg/20 mL | 20 pcs(10 pcs) | 5010-68024 |
| | 1 g/500 mg/6 mL | 30 pcs(10 pcs) | 5010-68023 |
| | 1 g/1 g/20 mL | 20 pcs(10 pcs) | 5010-68025 |
| InertSep GC/PSA | 50 mg/50 mg/1 mL | 50 pcs | 5010-68016 |
| | 50 mg/125 mg/1 mL | 50 pcs | 5010-68017 |
| | 300 mg/500 mg/6 mL | 30 pcs(10 pcs) | 5010-68011 |
| | 500 mg/500 mg/6 mL | 30 pcs(10 pcs) | 5010-68012 |
| | 500 mg/500 mg/20 mL | 20 pcs(10 pcs) | 5010-68014 |
| | 1 g/1 g/20 mL | 20 pcs(10 pcs) | 5010-68015 |
| | 1 g/500 mg/6 mL | 30 pcs(10 pcs) | 5010-68013 |

InertSep SAX/PSA

InertSep SAX/PSA is a two-layer SPE cartridge packed with SAX and PSA. It is specifically used to remove agrochemical compounds that are often difficult to remove from crop samples by polar interactions.

Two Layer Syringe-Barrel Type

| Description | Bed Weight/Volume | Qty.(pk unit) | Cat.No. |
|------------------|---------------------|----------------|------------|
| InertSep SAX/PSA | 250 mg/250 mg/3 mL | 50 pcs(10 pcs) | 5010-68100 |
| | 500 mg/500 mg/6 mL | 30 pcs(10 pcs) | 5010-68101 |
| | 500 mg/500 mg/20 mL | 20 pcs(10 pcs) | 5010-68104 |
| | 1 g/1 g/20 mL | 20 pcs(10 pcs) | 5010-68105 |

InertSep GC/PSA/SI, GC/SAX/PSA

InertSep GC/PSA/SI is more efficient for removing a wide variety of polar matrix compounds than GC/PSA. InertSep GC/SAX/PSA are able to be used for cleanup of processed food.

Three Layer Syringe-Barrel Type

| Description | Bed Weight/Volume | Qty.(pk unit) | Cat.No. |
|---------------------|----------------------------|----------------|------------|
| InertSep GC/PSA/SI | 500 mg/500 mg/500 mg/20 mL | 20 pcs(10 pcs) | 5010-68034 |
| InertSep GC/SAX/PSA | 500 mg/500 mg/500 mg/20 mL | 20 pcs(10 pcs) | 5010-68044 |

InertSep GC/SAX/PSA/SI

InertSep GC/SAX/PSA/SI is a four layer SPE cartridge. GC has ability for the isolation removal of pigments and SAX, PSA and SI offer superior cleanup when conducting multi-residue pesticide analysis.

Four Layer Syringe-Barrel Type

| Description | Bed Weight/Volume | Qty.(pk unit) | Cat.No. |
|------------------------|------------------------------------|----------------|------------|
| InertSep GC/SAX/PSA/SI | 500 mg/500 mg/500 mg/500 mg /20 mL | 20 pcs(10 pcs) | 5010-68054 |

InertSep SAX/PSA/SI

InertSep SAX/PSA/SI is a three-layer SPE cartridge for cleanup. It is available for sample cleanup to make analysis of residual pesticides.

Three Layer Syringe-Barrel Type

| Description | Bed Weight/Volume | Qty.(pk unit) | Cat.No. |
|---------------------|-----------------------------|----------------|------------|
| InertSep SAX/PSA/SI | 500 mg/500 mg/500 mg /20 mL | 20 pcs(10 pcs) | 5010-68114 |

InertSep C18/DRY

InertSep C18/DRY is a two-layer SPE cartridge and designed for sample preparation for residual pesticide analysis. C18 is to remove lipids and DRY is for dehydration.

Two Layer Syringe-Barrel Type

| Description | Bed Weight/Volume | Qty.(pk unit) | Cat.No. |
|------------------|-------------------|---------------|------------|
| InertSep C18/DRY | 1 g/3 g/12 mL | 20 pcs(1 pc) | 5010-68133 |

InertSep C18/SAX/PSA,AL-N/C18/SAX/PSA

Three- and four-layer-type solid phase extraction cartridges are used for rapid simultaneous analysis of pesticide residues. Since graphite carbon is not used, the purification process can be performed with only a small amount of acetonitrile solvent without toluene. For particularly pigmented samples, the four-layer-type AL-N/C18/SAX/PSA can be recommend.

Three and Four-Layer Syringe-Barrel Type

| Description | Bed Weight/Volume | Qty. | Cat.No. |
|---------------------------|----------------------------------|---------|------------|
| InertSep C18/SAX/PSA | 200 mg/100 mg/100 mg/1 mL | 100 pcs | 5010-68110 |
| InertSep AL-N/C18/SAX/PSA | 100 mg/200 mg/100 mg/100 mg/1 mL | 50 pcs | 5010-68111 |

InertSep Slim-J DRY

Na₂SO₄

InertSep Slim-J DRY cartridge is packed with anhydrous Na₂SO₄ for dehydration.

Luer-Device Cartridges

| Description | Bed Weight/Volume | Qty.(pk unit) | Cat.No. |
|---------------------|-------------------|---------------|------------|
| InertSep Slim-J DRY | 1.4 g | 50 pcs(1 pc) | 5010-65700 |
| | 2.8 g | 50 pcs(1 pc) | 5010-65701 |

InertSep PCB

InertSep PCB is a two-layer SPE cartridge packed with SCX and SI. It has been designed for the extraction of PCBs from complex matrix.

Syringe-Barrel Cartridges

| Description | Bed Weight/Volume | Qty.(pk unit) | Cat.No. |
|--------------|-------------------|---------------|------------|
| InertSep PCB | 1 g/3 mL | 50 pcs(5 pcs) | 5010-68121 |
| | 1 g/6 mL | 30 pcs(1 pc) | 5010-68120 |

InertSep Phospholipid Remover



InertSep Phospholipid has both excellent phospholipid removal ability and low adsorption, and can be used for serum and plasma samples, etc.

| Description | Bed Weight/Volume | Qty | Cat.No. |
|-------------------------------|-------------------|---------|------------|
| InertSep Phospholipid Remover | 50 mg/1 mL | 100 pcs | 5010-27810 |
| | 100 mg/3 mL | 50 pcs | 5010-27811 |

InertSep K-solute(Diatomaceous earth)



InertSep K-solute

InertSep K-solute is packed with diatomaceous earth and ideal for the sample to form an emulsion during liquid-liquid extraction procedures. Dedicated rack for InertSep makes the operation simple and efficient further more.

Reservoir dimensions

| Volume of Used Reservoir | O.D. | Length |
|--------------------------|-------|--------|
| 12 mL | 18 mm | 90 mm |
| 20 mL | 23 mm | 99 mm |
| 60 mL | 30 mm | 155 mm |
| 150 mL | 41 mm | 172 mm |

Procedure 1 Apply a sample to InertSep K-solute



Procedure 2 Leave it to stand for 5 to 15 minutes

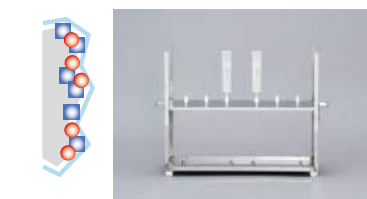

Procedure 3 Elute with an elution solvent



Syringe-Barrel Cartridges

| Description | Reservoir Volume | Sample Volume | Qty. | Cat.No. |
|-------------------|------------------|---------------|---------|------------|
| InertSep K-solute | 12 mL | 2 mL | 100 pcs | 5010-68125 |
| | | | 100 pcs | 5010-68127 |
| | 60 mL | 10 mL | 25 pcs | 5010-68208 |
| | | | 100 pcs | 5010-68218 |
| | | | 25 pcs | 5010-68209 |
| | | | 100 pcs | 5010-68219 |
| | 150 mL | 50 mL | 25 pcs | 5010-68210 |
| | | | 50 pcs | 5010-68220 |

Bulk

| Description | Qty. | Cat.No. |
|--|------|------------|
| Sorbent Supported Liquid Extraction (Bulk) | 1 kg | 5010-69500 |

Adaptors

| Description | Qty. | Cat.No. |
|--|--------|------------|
| Connecting Adaptor (PP) 1, 3, 6 mL Reservoir | 12 pcs | 5010-60000 |
| Connecting Adaptor (PP) 12, 20 mL Reservoir | 12 pcs | 5010-60001 |
| Connecting Adaptor (PP) 60 mL Reservoir | 12 pcs | 5010-60002 |
| Connecting Adaptor (PP) 150 mL Reservoir | 1 pc | 5010-50336 |
| Connecting Adaptor (PP) LSC Reservoir | 12 pcs | 5010-60004 |

Reservoir with Adaptors

| Description | Qty. | Cat.No. |
|--|--------|------------|
| Reservoir with Adaptor for 1, 3, 6 mL | 12 pcs | 5010-60015 |
| 50 mL Reservoir with Adaptor for 12, 20 mL | 12 pcs | 5010-60016 |
| 200 mL Reservoir with Adaptor for 60 mL | 12 pcs | 5010-60017 |

InertSep VRA (Multifunctional Cleanup SPE Cartridge for Aflatoxins)

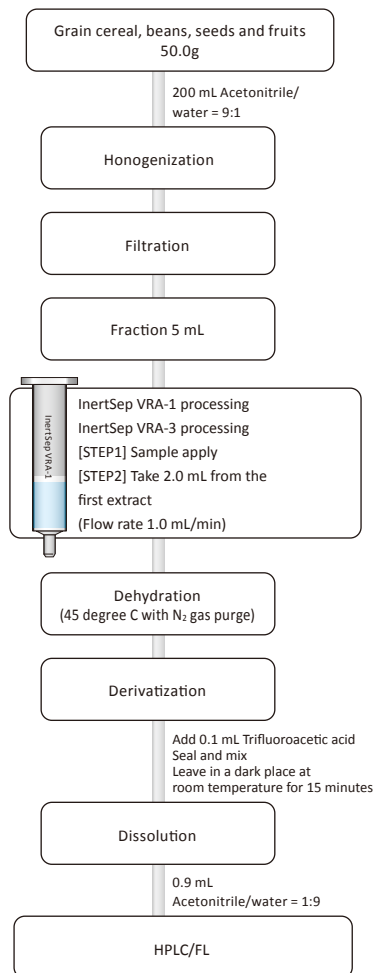

Total Aflatoxin Analysis

A number of mycotoxins are contained in natural food products. Among these, Aflatoxins produced by fungus such as *Aspergillus flavus* are carcinogenic to liver cells, and have attracted considerable attention in food safety.

InertSep VRA Series

InertSep VRA series are multifunctional solid phase extraction cartridges for cleanup samples in complex organic matrices.

● Feature

These multifunctional cartridges have the advantages of both reversed phase and ion exchange silica-based sorbents.

| Description | Details | Qty. | Cat.No. |
|----------------|--|--------|------------|
| InertSep VRA-1 | Mix mode: Reversed and ion exchange phase (Column size : 6 mL) | 30 pcs | 5010-68140 |
| InertSep VRA-2 | Economy model of VRA-1 (Column size : 6 mL) | 30 pcs | 5010-68141 |
| InertSep VRA-3 | Strong reversed phase model (Column size : 6 mL) | 30 pcs | 5010-68142 |

InertSep VRA-RP (Multifunctional Cleanup SPE Cartridge for pesticide residue analysis and biological samples)

InertSep VRA-PR

InertSep VRA-PR is a solid-phase mini-column for trace cleanup in biological samples and for cleanup of QuEChERS samples in pesticide residue analysis.

For removal of strong pigment components, columns stacked with "AL-N" are recommended.

● Feature

- These multifunctional cartridges have the advantages of both reversed phase and ion exchange silica-based sorbents.

| Description | Bed Weight/Volume | Qty. | Cat.No. |
|----------------------|-------------------|---------|------------|
| InertSep VRA-PR | 400mg/1mL | 100 pcs | 5010-68153 |
| InertSep VRA-PR | 1600mg/6mL | 30 pcs | 5010-68154 |
| InertSep AL-N/VRA-PR | 100mg/50mg/1mL | 100 pcs | 5010-68150 |
| InertSep AL-N/VRA-PR | 400mg/1600mg/6mL | 30 pcs | 5010-68151 |
| InertSep AL-N/VRA-PR | 100mg/400mg/1mL | 100 pcs | 5010-68152 |

InertSep mini AERO series

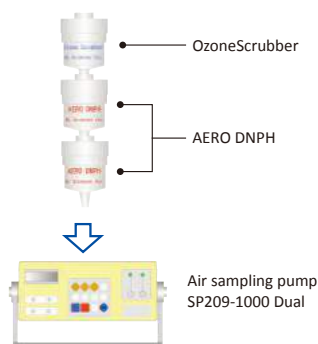

Ex 1) How to use InertSep mini AERO

Note) Use the OzoneScrubber depending on the requirement

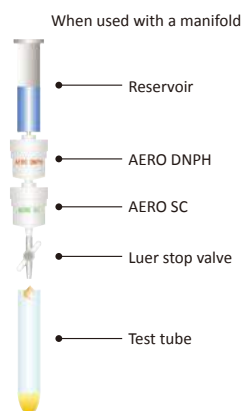

Ex 2) How to use InertSep mini AERO

InertSep mini AERO series are active samplers for the analysis of aldehydes and ketones in outdoor gas, car cabin and exhaust gas in compliance with: Offensive Odor Control Law, Clean Air Act, and EPA. There are four types: AERO DNPH, AERO DNPH-HR, AERO OzoneScrubber, and AERO SC, InertSep mini AERO series.

● Features

InertSep mini AERO DNPH

This active sampler is packed with spherical silica coated with 2,4-Dinitrophenylhydrazine reagent for derivatization of aldehydes and ketones. The size of 120 μm spherical silica allows for high air permeability, resulting in high collection efficiency of the target compounds and low blank compared with irregular silica.

InertSep mini AERO DNPH-HR

This is newly developed and offers improved efficiency for acrolein collection, which is difficult to collect with the conventional DNPH cartridges.

InertSep mini AERO OzoneScrubber

Potassium iodide is used to remove ozone interference. It is known that the DNPH derivatives are decomposed by ozone, which affects the results. InertSep AERO OzoneScrubber is used in series with DNPH cartridge at its inlet side.

InertSep mini AERO SC

This cartridge is packed with polymeric packing material of strong cation exchange to remove unreacted DNPH.

Unreacted DNPH interferes with GC analysis, so is connected to the outlet side of DNPH cartridge.

| Description | Bed Weight | Qty. | Cat.No. |
|-----------------------------------|------------|--------|------------|
| InertSep mini AERO DNPH [●R/F] | 300 mg | 20 pcs | 5010-23500 |
| InertSep mini AERO DNPH-HR [●R/F] | 300 mg | 20 pcs | 5010-23501 |
| InertSep mini AERO OzoneScrubber | 1.5 g | 20 pcs | 5010-23510 |
| InertSep mini AERO SC | 250 mg | 20 pcs | 5010-23520 |

Note: [●R/F] Refrigerated/Freezing

InertSep Slim-J AERO SDB400

InertSep Slim-J AERO SDB400 is used for extraction of semi-volatile organic compounds like insecticides and fire retardants in air.

| Description | Bed Weight | Qty. | Cat.No. |
|-----------------------------|------------|--------|------------|
| InertSep Slim-J AERO SDB400 | 400 mg | 20 pcs | 5010-65780 |



2. Accessories for SPE

| | |
|-------------------------------|----|
| ● Vacuum Manifold | 64 |
| ● Reservoir and Adaptor | 68 |
| ● Tube | 70 |
| ● Gravity Flow Manifold | 72 |
| ● Other Accessories | 75 |
| ● Syringe Filter | 76 |

Introduction of InertSep Vacuum Manifold System

InertSep vacuum manifold is specially developed for performing efficient solid phase extraction. According to the application there are various kinds of useful kits and options.

2

Accessories for SPE

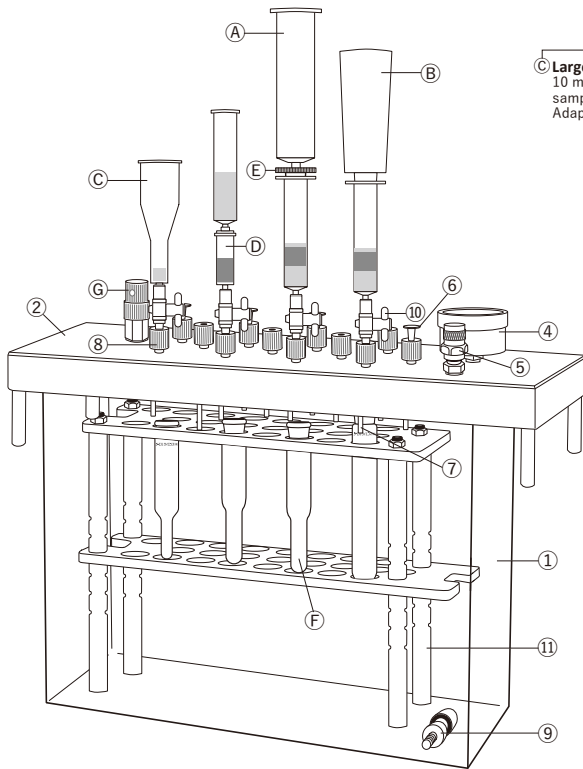

C Large Size Cartridge
10 mL reservoir used with samples up to 10 mL. Adaptor not required.

A Empty Reservoir
1 mL to 150 mL reservoirs are available for large sample amount. Requires a connecting adaptor.

B Reservoir with adaptor
Ideal for use in the pretreatment of food. Useful when using a cleanup volume of 20 mL approx.

D Luer Device Cartridge
Used for connecting a solid phase cartridge, connecting an empty reservoir or connection to a automatically instrument for solid phase extraction.

E Connecting adaptor for InertSep
Used to connect a syringe barrel type regular cartridge to another luer device.

10 5010-60010 Luer Stop Valve (PTFE)
Used to control or stop the flow rate during solid phase extraction.

2 5010-50238 Top Cover Assembly
Fit onto the glass chamber to perform solid phase extraction.

G Safety valve
Used to prevent excessive applied vacuum breaking the glass chamber.

6 5010-50016 Sealing plug
Need to plug any line not being used.

4 5010-50014 Vacuum gauge
Display the level of vacuum in the glass chamber.

5 5010-50015 Bleed valve
Used to adjust the amount of vacuum applied. Adjust while monitoring the pressure displayed on the vacuum gauge.

8 5010-50032 PTFE Luer fitting
A luer type connection can be made, e.g. with a solid phase cartridge or filter disk. Also used to connect the delivery tips to the cover.

7 5010-50019, 5010-50020 Delivery Tips
The standard delivery tip is manufactured from stainless steel (5010-50019). When correction resistance is required, use the PTFE type (5010-50020).

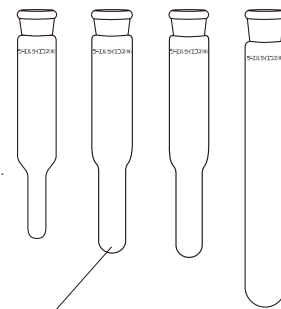

F 5010-51010 etc, GL-SPE
Concentration tubes There are 11 different sizes. Select, depending on the volume of the extraction solvent and concentration volume.

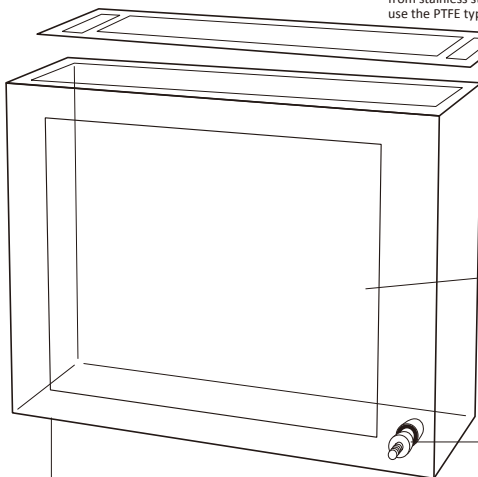

3 5010-50239 Gasket
Used to seal the cover assembly and the glass chamber to maintain vacuum.

14 5010-50018 Stainless steel nut for rack
5010-50129 Hexagon nut M6x4 for rack

12 5010-50041 Glass protection film

13 5010-50017 O-ring
5010-50128 Resin clip for rack

9 5010-50033 Vacuum tube connector assembly
Vacuum tube connector Used to connect the glass chamber to the vacuum pump.

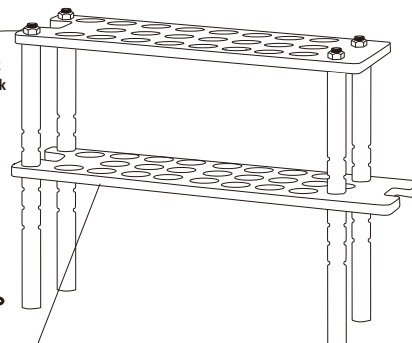

11 5010-50240 Bottom plate
There 5 type of racks: 12/16 mm test tube, 20 mL concentration tube, 30 mL Concentration tube, TS 29/38 eggplant shaped flask, TS 29/38 Florence flask 50/100 mL.

InertSep Vacuum Manifold Kit



5010-50230



5010-50234



5010-50235



5010-50233

For the efficient SPE analysis using InertSep vacuum manifold system, necessary accessories are provided as a kit for general or environmental analysis which needed many samples such as river water. Some kits are suitable for your analytical purposes.

| Description | Specification | Qty. | Cat.No. |
|--|---|-------|------------|
| InertSep Vacuum Manifold Kit 12/16 mm (for Test Tube/ Concentration Tube) 12 Samples | Glass Chamber: 1 pc Cover 1 pc Gasket 1 pc Vacuum Gauge 1 pc Bleed Valve 1 pc Safety Valve 1 pc Plug 12 pcs Cartridge Adaptor 12 pcs PTFE Female Luer 12 pcs Stainless Delivery Tip 12 pcs PTFE Delivery Tip 12 pcs 12/16 mm Rack 1 pc 12 mm Waste Liquid Funnel 12 pcs 16 mm Waste Liquid Funnel 12 pcs | 1 set | 5010-50230 |
| InertSep Vacuum Manifold Kit (for 4 Eggplantshaped Flasks) | Glass Chamber: 1 pc Cover 1 pc Gasket 1 pc Vacuum Gauge 1 pc Bleed Valve 1 pc Safety Valve 1 pc Plug 4 pcs PTFE Female Luer 12 pcs Stainless Delivery Tip 12 pcs TS29/38 Rack for 4 Florence Flasks 1 pc PTFE Delivery Tip 4 pcs | 1 set | 5010-50234 |
| InertSep Vacuum Manifold Kit 20 (for 20 samples-20/30 mL Concentration Tube) | Glass Chamber 1 pc Gasket 1 pc, plug 20 pcs Stainless Delivery Tip 20 pcs PTFE Delivery Tip 20 pcs Rack for 20/30 mL Concentration Tube 1 pc Vacuum Controller 1 pc | 1 set | 5010-50235 |
| InertSep Vacuum Manifold Kit for Inorganic Analysis For 50 mL DigiTUBE/8 Samples | Glass chamber 1 pc Cover (for 8 samples) 1 pc Gasket 1 pc Vacuum Gauge (SUS) 1 pc Bleed Valve (SUS) 1 pc Safety Valve (SUS) 1 pc Plug 8 pcs Luer Stop Valve (PTFE) 8 pcs PTFE Female Luer 8 pcs Delivery Tip (PTFE) 8 pcs DigiTUBE Rack 1 pc | 1 set | 5010-50233 |

*Parts used for inorganic analysis are made of different materials. See page 67 for details.

SPE Vacuum Kit

2

Accessories for SPE



5010-50040

The SPE Vacuum Kit is used in combination with the InertSEP aspiration manifold for solid phase extraction. The starter kit is a basic vacuum kit combined with a concentration tube and other components.

| Description | Specification | Qty. | Cat.No. |
|----------------|---|-------|------------|
| SPE Vacuum Kit | Diaphragm vacuum pump Suction Filtration Bottle Vacuum Hose 2 m Silicon Plug Hose connector | 1 set | 5010-50040 |

Option for SPE Vacuum kit

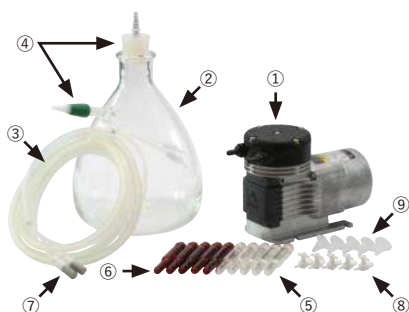

Option for SPE Vacuum kit

| No. | Description | Specification | Qty. | Cat.No. |
|-----|-------------------------------|--|--------|------------|
| ① | Diaphragm vacuum pump | – | 1 pc | 5010-50026 |
| ② | Suction Filtration Bottle 3 L | With a silicon plug and a hose connector set | 1 set | 5010-50028 |
| – | Suction Filtration Bottle 1 L | With a silicon plug and a hose connector set | 1 set | 5010-50027 |
| ③ | Vacuum Hose | 2 m | 1 pc | 5010-50030 |
| ④ | Hose Connector set | – | 1 set | 5010-50029 |
| ⑤ | GL-SPE Concentration Tube | 0.5 mL&1.0 mL/7 mL Clear Taper | 10 pcs | 5010-51013 |
| ⑥ | GL-SPE Concentration Tube | Brown 0.5 mL · 1.0 mL/7 mL Clear Taper | 10 pcs | 5010-51014 |
| ⑦ | Ls Tubing 6 | with Cartridge Connection Adapter | 6 pcs | 5010-50212 |
| ⑧ | Lure Stop Valve | PTFE | 12 pc | 5010-60010 |
| ⑨ | SPE Cartridge Adaptor | for 1,3,6 mL (PP) | 12 pc | 5010-60000 |

Accessories for Vacuum Manifold



5010-50238



5010-50024

5010-50022



5010-60010



5010-50249



5010-50122



5010-50127

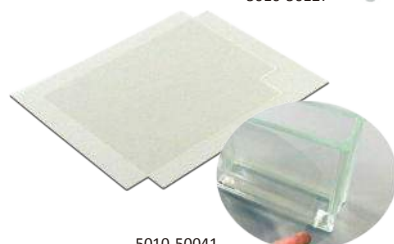

5010-50041

InertSep/GL-SPE Vacuum Manifold Accessories

| No. * | Description | Specification | Qty. | Cat.No. |
|-------|-------------------------|--|--------|------------|
| ① | Glass Chamber | Suction Tube Connector 1 pc | 1 pc | 5010-50237 |
| | | For Inorganic Compounds Analysis | 1 pc | 5010-50243 |
| ② | Top Cover Assembly (PE) | For General Analysis | 1 pc | 5010-50238 |
| | | For Inorganic Compounds Analysis | 1 pc | 5010-50244 |
| | | Eggplant Flask 4 pcs | 1 pc | 5010-50247 |
| | | For 20 Samples | 1 pc | 5010-50254 |
| ③ | Gasket | Polystyrene Foam | 2 pcs | 5010-50239 |
| ④ | Vacuum Gauge | For General Analysis (Brass) | 1 pc | 5010-50014 |
| | | For Inorganic Compounds Analysis (Stainless Steel) | 1 pc | 5010-50123 |
| ⑤ | Bleed Valve | For General Analysis (Brass) | 1 pc | 5010-50015 |
| | | For Inorganic Compounds Analysis (Stainless Steel) | 1 pc | 5010-50124 |
| ⑥ | Plug | PP | 12 pcs | 5010-50016 |
| ⑦ | Stainless Delivery Tip | Stainless Steel | 12 pcs | 5010-50019 |
| | | PTFE Delivery Tip | PTFE | 12 pcs |
| — | 12 mm Waste Funnel | PP | 12 pcs | 5010-50022 |
| — | 16 mm Waste Funnel | PP | 12 pcs | 5010-50024 |
| ⑧ | Luer Fitting | PTFE | 12 pcs | 5010-50032 |
| ⑨ | Vacuum Tube Connector | (PP, Fluoro Rubber) | 1 pc | 5010-50033 |
| | | For Inorganic Compounds Analysis (PP, Perfluor) | 1 pc | 5010-50125 |
| ⑩ | Luer Stop Valve | PTFE | 12 pcs | 5010-60010 |
| | | Luer Flow Control Valve | PP | 10 pcs |

Accessories for InertSep Vacuum Manifold Kit

| No. * | Description | Specification | Qty. | Cat.No. |
|-------|-----------------------|--|--------|------------|
| ⑪ | Rack(PE) | 12 mm/16 mm Test Tube, 7 mL Concentration Tube (for 12 Samples) | 1 pc | 5010-50240 |
| | | 20 mL (for Test Tube with Funnel O.D. 22 mm, 12 Samples) | 1 set | 5010-50241 |
| | | 30 mL (for Test Tube with Funnel O.D. 22 mm, 12 Samples) | 1 set | 5010-50242 |
| | | TS29/38 50 mL 4 pcs or 100 mL 2 pcs Eggplant Flask | 1 pc | 5010-50249 |
| | | 50 mL DigiTUBE for Inorganic Compounds Analysis/8 Samples | 1 pc | 5010-50246 |
| | | 7 mL Concentration Tube, 16 mm Test Tube (for 20 Samples) | 1 pc | 5010-50256 |
| | | 20/30 mL Concentration Tube (for 20 Samples) | 1 pc | 5010-50253 |
| — | Waste Tray | Stainless Steel | 1 pc | 5010-50122 |
| — | Drain Plate | For Inorganic Compounds Analysis (PP and POM:Legs) | 1 pc | 5010-50127 |
| ⑫ | Glass Protection Film | Prevention of scattering when glass breaks (PE) | 2 pcs | 5010-50041 |
| ⑬ | O-Ring | For fixing rack lower plate (FKM) | 10 pcs | 5010-50017 |
| ⑭ | SUS Nut | For fixing rack upper plate (Stainless Steel) | 4 pcs | 5010-50018 |
| ⑮ | Resin Clip | For fixing rack lower plate for Inorganic Compounds Analysis(FKM) | 4 pcs | 5010-50128 |
| ⑯ | Resin Nut | For fixing rack upper plate for Inorganic Compounds Analysis (Stainless Steel) | 4 pcs | 5010-50129 |

* Refer in 64 page figure

InertSep Empty Reservoirs and Frits



An empty reservoir made of PP. It is useful for pouring conditioning solutions into luer device–type or small-volume cartridges or for sample loading. When filling with a filler, use fritted.

Size

| Volume | O.D. (mm) | I.D. (mm) | Length (mm) | Volume | O.D. (mm) | I.D. (mm) | Length (mm) |
|--------|-----------|-----------|-------------|--------|-----------|-----------|-------------|
| 1 mL | 7.7 | 5.7 | 66 | 20 mL | 22.9 | 20.1 | 99 |
| 3 mL | 10.9 | 8.9 | 75 | 60 mL | 30 | 26.7 | 155 |
| 6 mL | 14.7 | 12.8 | 78 | 150 mL | 41 | 37.7 | 172 |
| 12 mL | 18 | 15.7 | 90 | | | | |

| Volume | Without Flit | | With 2 pcs Flits* | |
|--------|--------------|------------|-------------------|------------|
| | Qty. | Cat.No. | Qty. | Cat.No. |
| 1 mL | 50 pcs | 5010-60100 | 50 pcs | 5010-60120 |
| 3 mL | 50 pcs | 5010-60101 | 50 pcs | 5010-60121 |
| 6 mL | 30 pcs | 5010-60102 | 30 pcs | 5010-60122 |
| 12 mL | 20 pcs | 5010-60103 | 20 pcs | 5010-60123 |
| 20 mL | 20 pcs | 5010-60104 | 20 pcs | 5010-60124 |
| 60 mL | 10 pcs | 5010-60105 | 10 pcs | 5010-60125 |
| 150 mL | 10 pcs | 5010-60106 | 10 pcs | 5010-60126 |

*: One frit is attached to the reservoir, and one is included.

| Description | Specification | Qty. | Cat.No. |
|----------------|---------------|---------|------------|
| Only Flit (PE) | For 1 mL | 100 pcs | 5010-60150 |
| | For 3 mL | 100 pcs | 5010-60151 |
| | For 6 mL | 60 pcs | 5010-60152 |
| | For 12 mL | 40 pcs | 5010-60153 |
| | For 20 mL | 40 pcs | 5010-60154 |
| | For 60 mL | 20 pcs | 5010-60155 |
| | For 150 mL | 20 pcs | 5010-60156 |

InertSep Cartridge Adaptors



It is attached to the top of a syringe–barrel type cartridge to connect an empty reservoir, and it is convenient for use when loading samples.

| Description | Specification | Qty. | Cat.No. |
|----------------------------------|---|--------|------------|
| InertSep Cartridge Adaptors (PP) | SPE Cartridge Adaptor for 1, 3, 6 mL (PP) | 12 pcs | 5010-60000 |
| | SPE Cartridge Adaptor for 12,20 mL (PP) | 12 pcs | 5010-60001 |
| | SPE Cartridge Adaptor for 60 mL (PP) | 12 pcs | 5010-60002 |
| | SPE Cartridge LSC Adaptor (PP) | 12 pcs | 5010-60004 |
| | SPE Cartridge Adaptor for 150 mL (PP) | 1 pc | 5010-50336 |

Reservoirs with Adaptor

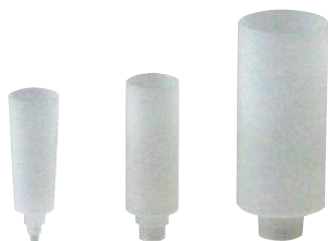

An adapter for connecting a solid phase column and a reservoir are integrated into one unit. There is no need to connect the adapter and reservoir. The tapered connection allows for a firm connection to a solid phase column.

| Description | Specification | Qty. | Cat.No. |
|--|---------------|--------|------------|
| 25 mL Reservoir with Adaptor for 1, 3, 6 mL SPE Cartridges | PP | 12 pcs | 5010-60015 |
| 50 mL Reservoir with Adaptor for 12, 20 mL SPE Cartridges | | 12 pcs | 5010-60016 |
| 200 mL Reservoir with Adaptor for 60 mL SPE Cartridges | | 12 pcs | 5010-60017 |

Luer Stop Valve



The flow rate can be adjusted simply by connecting the solid phase column to the manifold and opening/closing a valve. The material is made of PTFE and has excellent solvent resistance.

| Description | Specification | Qty. | Cat.No. |
|-----------------|---------------|--------|------------|
| Luer Stop Valve | PTFE | 12 pcs | 5010-60010 |

Waste Container for Vacuum Manifold



5010-50122



5010-50127

It is placed in a glass chamber and used to collect the effluent that has passed through the solid phase column.

| Description | Specification | Qty. | Cat.No. |
|-------------|---|------|------------|
| Waste Tray | Stainless Steel | 1 pc | 5010-50122 |
| Drain Plate | PP and POM: Legs (for Inorganic Compounds Analysis) | 1 pc | 5010-50127 |

Useful Items for Vacuum Manifold



The sealing plug has the same luer-tip shape as the tip of the solid phase column. It can plug ports that are not in use, such as suction manifolds.

| Description | Specification | Qty. | Cat.No. |
|--------------|---------------|--------|------------|
| Sealing Plug | PP | 12 pcs | 5010-50016 |

Note: Twelve plugs are included with the InertoSep Suction Manifold Kit and system.

LS Tubing

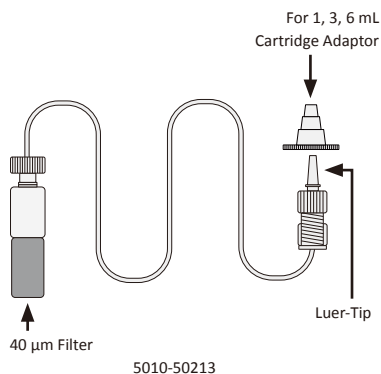

A tube with a 40-µm pore-size filter and lure tip type adapter.

It prevents debris and dirt from flowing into the solid phase column when a large-volume of sample water is passed through.

(If the SS component is particularly high, prefiltration is recommended before use, if necessary.)

The length of the tube is ~1 m.

LS Tubing 1, 6, and 12 come with cartridge adapters (for 1, 3, and 6 mL).

| Description | Specification | Qty. | Cat.No. |
|--------------|--|--------|------------|
| LS Tubing 0 | without Cartridge Connection Adapter | 1 pc | 5010-50214 |
| LS Tubing 1 | with Cartridge Connection Adapter 1 pc | 1 pc | 5010-50213 |
| LS Tubing 6 | with Cartridge Connection Adapter 6 pcs | 6 pcs | 5010-50212 |
| LS Tubing 12 | with Cartridge Connection Adapter 12 pcs | 12 pcs | 5010-50211 |

GL-SPE Concentration tubes/Test tubes

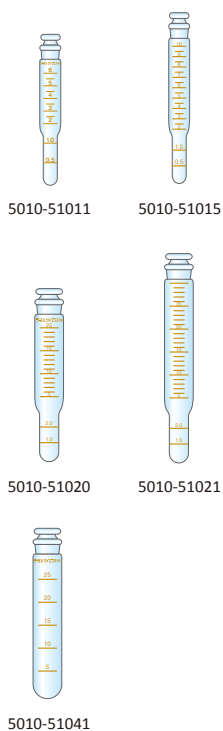

GL-SPE Concentration Tubes are collection tubes used to collect eluted solutions from solid phase columns. Some of the concentration tubes and test tubes are equipped with a scalpel scale so that the collected eluate can be concentrated or volume-constituted by adding a solvent without transferring the eluate to another test tube or other container.

| Description | Color | Scale (Volume) mL | O.D. mm | Scale (Max. Volume) mL | Plug | Qty. | Cat.No. | |
|--|-------------------|-------------------|----------|------------------------|--------------|----------------|------------|--------------------|
| Co-Stoppered Graduated Tube Spitz Tube 12 mm | Clear | — | 12 | 6(6.5) | Co-Stoppered | 20 pcs | 5010-51001 | |
| Co-Stoppered Graduated Tube Spitz Tube 16 mm | Clear | — | 16 | 14(15) | | 20 pcs | 5010-51002 | |
| GL-SPE Concentration Tube | Clear | 1.0 mL | | 6(7) | 10(10.5) | Tapered | 10 pcs | 5010-51010 |
| | Clear | 0.5&1.0 mL | | | | | 10 pcs | 5010-51011 |
| | Amber | | | | | 10 pcs | 5010-51012 | |
| | Clear | | | | | 10 pcs | 5010-51013 | |
| | Amber | | | | | 10 pcs | 5010-51014 | |
| | GL-SPE Test Tubes | Clear | | | | 1.0&2.0&5.0 mL | 22 | 5(6) ^{*1} |
| Clear | | 10 pcs | | 5010-51016 | | | | |
| Clear | | 1.0&2.0 mL | 20(20.5) | 10 pcs | 5010-51017 | | | |
| Clear | | 1.0&2.0 mL | 30(30) | 6 pcs | 5010-51020 | | | |
| Clear | | 5.0 mL | 16.5 | 5(16) | Tapered | 6 pcs | 5010-51021 | |
| Clear | | 5.0&10 mL | | | | 10 pcs | 5010-51040 | |
| Amber | 5.0 mL | 10 pcs | | | | 5010-51039 | | |
| Clear | — | 22 | | | | 5(9) | 10 pcs | 5010-51042 |
| | | | | 25 ^{*2} | — | 6 pcs | 5010-51041 | |

1: Scaled to 0.1 and 0.2 mL.

2: Scaled to 5 mL.

Note: Scales other than the female scale and the spitz tube scale indicate approximate amounts.

Racks



5010-50034

(Concentration tube not included)

Racks are available to match the shape of the eluate receiver (This is for both the InertSEP suction manifold and the GL-SPE suction manifold).

| Description | Specification | Diameter | Qty. | Cat.No. |
|-------------|---|--------------------------|-------|------------|
| Rack (PE) | 12 mm/16 mm Test Tube (for 12 Samples) | 12.5 mm/17 mm | 1 pc | 5010-50240 |
| | 20 mL Concentration Tube with Funnel (for 12 Samples) | φ23 (For Funnel φ13m) | 1 set | 5010-50241 |
| | 30 mL Test Tube with Funnel (for 12 Samples) | | 1 set | 5010-50242 |
| | TS29/38 50 mL 4 pcs or 100 mL 2 pcs Eggplant Flask | 32 mm (30 mm) | 1 pc | 5010-50249 |
| | For 50 mL DidiTUBEs (for Inorganic Compounds Analysis,8 Samples) | 31 mm | 1 pc | 5010-50246 |
| | 7 mL Concentration Tube, 16 mm Test Tube (for 20 Samples) | 17 mm | 1 pc | 5010-50256 |
| | 20/30 mL Concentration Tube (for 20 Samples) | 23 mm | 1 pc | 5010-50253 |

Adapters for Backflush

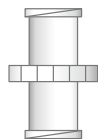

5010-52013

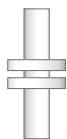

5010-52012



5010-52011 example

The back-flush adapter is used when eluting solid phase columns from the opposite direction of the flow direction.

| Description | Specification | Qty. | Cat.No. |
|-------------------------------------|--------------------------------------|--------|------------|
| Male Luer Union for Backflush | Luer Tip Male on both Sides (PP) | 10 pcs | 5010-52012 |
| Female Luer Union for Backflush | Luer Tip Female on both Sides (PP) | 10 pcs | 5010-52013 |
| Backflush Adaptor for SPE Cartridge | Luer Tip Female on both Sides (PTFE) | 5 pcs | 5010-52011 |

GL-SPE Gravity Flow Manifold



5010-50430

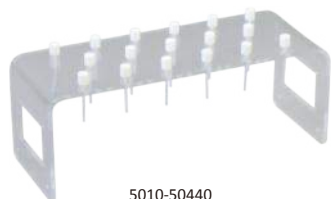

5010-50440

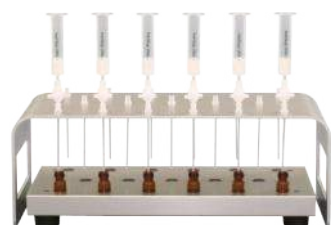

5010-50430 + 5010-50432
Combination Example

The GL-SPE natural drop manifold is optimized for solid phase extraction using the natural drop method. Twenty-four delivery tips are included.

- Simple design
- Optimal performance for Mycotoxins sample preparation
- Gravity flow is improved with the delivery tips
- Luer stop valve offers the adjustment of flow rate
- Optional extension panels for 4 mL Vials, GL-SPE concentration tubes and eggplant flasks are available

| Description | Specification | Qty. | Cat.No. |
|------------------------------|--|-------|------------|
| GL-SPE Gravity Flow Manifold | For General Analysis (Aluminum) | 1 set | 5010-50430 |
| | For Inorganic Compounds Analysis (PVC) | 1 set | 5010-50440 |

Accessories for Gravity Flow Manifold

| Description | Specification | Qty. | Cat.No. |
|------------------------------------|--|---------|------------|
| Extension Panel (Adjusting Height) | For General Analysis (Aluminum) | 2 pcs | 5010-50431 |
| | For Inorganic Compounds Analysis (PVC) | 2 pcs | 5010-50441 |
| Delivery Tips | For Gravity Flow(PP) | 24 pcs | 5010-50420 |
| | | 100 pcs | 5010-50421 |
| Luer Stop Valve | PTFE | 12 pcs | 5010-60010 |
| Tray (Aluminum) | For 4 mL Vials | 1 pc | 5010-50432 |
| | For 20 mL Concentration Tubes | 1 pc | 5010-50433 |
| | For 200/300 mL Eggplant-Shaped Flask | 1 pc | 5010-50434 |

GL-SPE Gravity Flow Rack



This rack is used to perform solid phase extraction operations by natural drop, such as InertSep K-solute. By adjusting the height of the stand, the receiver size and stand can be selected and set. Twelve samples can be processed simultaneously.

| Description | Specification | Qty. | Cat.No. |
|-------------------------------------|-----------------|-------|------------|
| GL-SPE Gravity Flow Rack Basic Unit | Stainless Steel | 1 set | 5010-50410 |

The basic unit does not include a stand for the receiver.

Accessories for GL-SPE Gravity Flow Rack

| Description | Specification | Qty. | Cat.No. |
|---|--------------------------------------|---------|------------|
| Gravity Flow Collection Stand (Stainless Steel) | For 50/100 mL Eggplant-Shaped Flask | 1 pc | 5010-50422 |
| | For 200/300 mL Eggplant-Shaped Flask | 1 pc | 5010-50423 |
| | For 20/30 mL Concentration Tubes | 1 pc | 5010-50424 |
| | For 50 mL Centrifuge Tube | 1 pc | 5010-50425 |
| Delivery Tip | For GL-SPE Gravity Flow | 24 pcs | 5010-50420 |
| | | 100 pcs | 5010-50421 |
| Luer Stop Valve | PTFE | 12 pcs | 5010-60010 |

For InertSep mini AERO DNPH

GL-SPE Manifold 20 for InertSep mini AERO DNPH



The InertSep Elution Manifold 20 is an InertSep mini AERO DNPH elution-only manifold. A flow-controlled (approximately 1 mL/min) spontaneous drop enables the efficient elution of up to 20 samples in DNPH cartridges after aldehyde collection.

No pumping equipment is required for elution.

It is capable of natural drop treatment at a flow rate of approx. 1 mL/min*.

It can reduce manual elution labor.

*: To perform elution by spontaneous drop, a 5 mL DNPH elution syringe is separately required. It is also extracted in the range of 0.6–1.2 mL/min when acetonitrile solvent is used (Flow rate cannot be changed).

| Description | Specification | Qty. | Cat.No. |
|----------------------|--|-------|------------|
| InertSep Manifold 20 | For InertSep mini AERO DNPH (20 Samples) | 1 set | 5010-50236 |

Accessories for InertSep Manifold 20

| Description | Specification | Qty. | Cat.No. |
|--|--|--------|------------|
| Top Cover Assembly | – | 1 pc | 5010-50251 |
| Delivery Tip | PTFE | 20 pcs | 5010-50134 |
| Gasket | For 20 Samples (For InertSep Vaccume Manifold) | 2 pcs | 5010-50252 |
| 7 mL Rack for Concentration Tubes and Test Tubes | For 20 Samples | 1 pc | 5010-50256 |

Note: Gaskets cannot be used in the common process.

Option for InertSep Manifold 20

| Description | Specification | Qty. | Cat.No. |
|--------------------------|----------------------------|-------|------------|
| Syringe for DNPH Elution | 5 mL Glass(without needle) | 6 pcs | 3008-41151 |

GL-SPE mini Vacuum Manifold

2

Accessories for SPE



GL-SPE mini Vacuum Manifold

GL-SPE mini vacuum manifold kit is space-saving, and kit 12C for cartridges and kit 96W for 96-well plates are available. Kit 12C can be used with SPE cartridge of up to 6 mL. As its option, vials can be placed.

● Features

- Two types for cartridges or 96-well plates
- Space-saving
- Concentration tubes, 7 mL test tubes and tubes with 16 mm O.D. x 100 mm length are placeable as connection tubes.

| Description | Format | Qty. | Cat.No. |
|--|---------------|------|------------|
| GL-SPE Mini Vacuum Manifold Kit 12C (12 place positions for SPE cartridges) | Cartridge | 1 pc | 5010-50150 |
| GL-SPE Mini Vacuum Manifold Kit 96W | 96-well plate | 1 pc | 5010-50155 |
| Vacuum Controller | Common | 1 pc | 5010-33071 |

Note: GL-SPE mini manifold kit 12C and 96W don't include the vacuum controller.

Accessories for GL-SPE Mini Manifold

| Description | Qty. | Cat.No. |
|--|--------|------------|
| GL-SPE Mini Vacuum Manifold Chamber for 12C | 1 pc | 5010-50160 |
| GL-SPE Mini Vacuum Manifold Top Plate for 12C * ¹ | 1 pc | 5010-50161 |
| GL-SPE Mini Vacuum Manifold Concentration Rack for 12C | 1 pc | 5010-50162 |
| GL-SPE Mini Vacuum Manifold Delivery Tip for 12C | 15 pcs | 5010-50163 |
| GL-SPE Mini Vacuum Manifold Chamber for 96W | 1 pc | 5010-50165 |
| GL-SPE Mini Vacuum Manifold Base Unit (Common) | 1 pc | 5010-50166 |
| GL-SPE Mini Vacuum Manifold Drain Plate (Common) | 1 pc | 5010-50167 |
| GL-SPE Mini Vacuum Manifold Shim Set 1 t x 2 pcs, 2 t x 1 pc for 96W | 1 set | 5010-50168 |
| GL-SPE Mini Vacuum Manifold Gasket Set * ² (Common) | 1 set | 5010-50169 |

*1 : Top Plate doesn't include delivery tip.

*2 : Gasket set contains a gasket for top side and a gasket for bottom side.

Eggplant-Shaped Flasks



A transparent sliding eggplant flask is used to collect the eluted liquid from the solid phase column. The sliding part is TS29/38.

| Description | Volume | Qty. | Cat.No. |
|-------------|--------|-------|-------------|
| TS29/38 | 50 mL | 2 pcs | 5010-51031 |
| | 100 mL | 2 pcs | 5010-51032 |
| | 200 mL | 2 pcs | 5010-51033* |

* : 200 mL eggplant flasks cannot be used with the inertosep aspiration manifold.

Connector Tubings

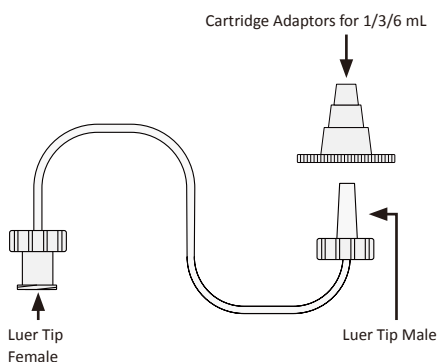

A 30-cm tube with lure tip male on one side and lure tip female on the other. One InertSep cartridge adapter (for 1, 3, and 6 mL) is included per bottle.

| Description | Specification | Qty. | Cat.No. |
|-------------------|-------------------|-------|------------|
| Connector Tubings | PTFE Tubing 30 cm | 1 pc | 5010-52021 |
| | | 5 pcs | 5010-52022 |

Cap for SPE Columns



Male luer cap

Female luer cap

It can be used as an inlet/outlet plug for luer device-type solid phase columns or as an unused plug for luer connections.

| Description | Specification | Qty. | Cat.No. |
|-----------------|---------------|--------|------------|
| Male luer cap | PP | 50 pcs | 5010-52015 |
| Female luer cap | | 50 pcs | 5010-52016 |

Plastic Disposable Syringe



A low-blank disposable syringe made of highly inert polypropylene. It can be used for filtration treatment prior to analysis. In addition, the Luer-lock type connection makes it easy to connect to a syringe.

| Description | Volume | Qty.(pcs) | Cat.No. |
|----------------------------|--------|-----------|------------|
| Plastic Disposable Syringe | 2 mL | 100 | 1030-55102 |
| | 5 mL | 100 | 1030-55105 |
| | 10 mL | 100 | 1030-55110 |
| | 20 mL | 100 | 1030-55120 |

GL Filter



Impurity particle removal filter for HPLC.

PTFE (hydrophobic and hydrophilic), Nylon, and PES are available as filter materials.

2

Accessories for SPE

Chemical resistance list

○ : Available, △ : Available for a short time, × : Disavailable, — : No Data

PTFE: Polytetrafluoroethylene
PES: Polyethersulfone

| | Filter Diameter | Pore size | PTFE Hydrophilic | PTFE Hydrophobic | Nylon | PES |
|---------------------------|---------------------------|-----------|---------------------|---------------------|---------------------|---------------------|
| Cat.No. Ring Color | 13 mm | 0.22 μm | 5040-29005 (GL0606) | 5040-29009 (GL0610) | 5040-29001 (GL0602) | 5040-29013 (GL0622) |
| | | 0.45 μm | 5040-29006 (GL0607) | 5040-29010 (GL0611) | 5040-29002 (GL0603) | 5040-29014 (GL0623) |
| | 25 mm | 0.22 μm | 5040-29007 (GL0608) | 5040-29011 (GL0612) | 5040-29003 (GL0604) | 5040-29015 (GL0624) |
| | | 0.45 μm | 5040-29008 (GL0609) | 5040-29012 (GL0613) | 5040-29004 (GL0605) | 5040-29016 (GL0625) |
| ACIDS | Acetic acid 25 | | ○ | ○ | ○ | ○ |
| | Hydrochloric acid 25% | | ○ | ○ | × | ○ |
| | Sulfuric acid 25% | | ○ | ○ | × | ○ |
| | Nitric acid 25% | | ○ | ○ | × | ○ |
| | Phosphoric acid 25% | | ○ | ○ | × | — |
| | Formic acid 25% | | ○ | ○ | × | — |
| Trichloroacetic acid 10% | | ○ | ○ | × | — | |
| Alcohol | Methyl alcohol 98% | | ○ | ○ | ○ | ○ |
| | Ethyl alcohol 70% | | ○ | ○ | △ | ○ |
| | Isopropyl alcohol | | ○ | ○ | ○ | ○ |
| | Butanol | | ○ | ○ | ○ | ○ |
| | Benzyl alcohol | | ○ | ○ | ○ | — |
| | Glycerinum | | ○ | ○ | ○ | ○ |
| Others | Triethanolamine | | ○ | ○ | ○ | — |
| | Aniline | | ○ | ○ | — | — |
| | Pyridine | | ○ | ○ | ○ | × |
| | Acetonitrile | | ○ | ○ | ○ | △ |
| | Ethyl acetate | | ○ | ○ | ○ | × |
| | N-butyl acetate | | ○ | ○ | ○ | × |
| | Propyl acetate | | ○ | ○ | ○ | × |
| | Cellosolve acetate | | ○ | ○ | — | × |
| | Methyl Cellosolve | | ○ | ○ | — | × |
| | Isopropyl myristate | | ○ | ○ | ○ | × |
| | Acetone | | ○ | ○ | ○ | × |
| | Cyclohexanone | | ○ | ○ | ○ | × |
| | Methyl ethyl ketone | | ○ | ○ | ○ | × |
| | Methyl-isobutyl Ketone | | ○ | ○ | — | × |
| | Dioxane | | ○ | ○ | ○ | × |
| | Tetrahydrofuran | | ○ | ○ | ○ | × |
| | Dimethyl sulfoxide | | ○ | ○ | ○ | × |
| | Isopropyl ether | | ○ | ○ | — | ○ |
| | Phenol solution 10% | | ○ | ○ | — | × |
| | Formaldehyde Solution 30% | | ○ | ○ | ○ | ○ |
| Hydrogen Peroxide | | ○ | ○ | ○ | — | |
| Silicone oil/silicone oil | | ○ | ○ | — | ○ | |

- The data in this table are reference values.
- Please try a small amount of sample in advance to confirm its safety before conducting the main experiment.

3. Products Related Life Sciences Analysis

| | |
|--|----|
| ● Filter Plate | 78 |
| ● Monolith Silica | 80 |
| ● MonoSpin | 81 |
| ● SPE Tip Columns for Trace Samples | 85 |
| ● Exosome | 86 |
| ● MonoSpin ProA, MonoSpin ProG, MonoSpin ProL | 88 |
| ● Phosphorylation Purification & Enrichment | 90 |
| ● Tip Columns for Enrichment of Phosphopeptides | 93 |
| ● Desalting and Enrichment Phosphopeptide/ Fractionation Tips | 94 |

FastRemover Series

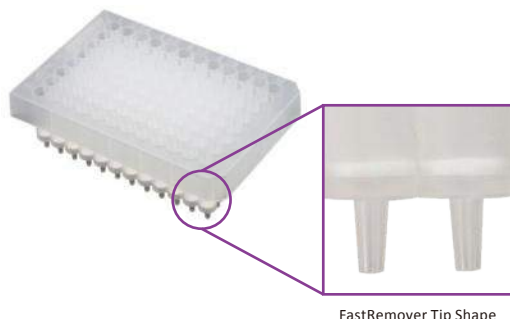

This 96-well filter plate uses a low adsorption filter and a housing with low elution of plasticizers and other substances. Serum and plasma samples can be processed easily and reliably.

- Can be used for high-sensitivity analysis due to a low blank to use pellets that have undergone a dissolution test.
- The tip has a long nozzle shape, which enables small-volume elution and prevents cross-contamination between wells.
- Can be used for processing with automated equipment due to its structure with excellent liquid permeability without clog error.

Filter Plate FastRemover MF

The UHPLC apparatus, which has been widely used in recent years, has a low pipe inner diameter to reduce dead volume, and it is said to have a high risk of system and column clogging because of particulate contamination. Therefore, it is recommended that the measurement sample also be passed through a 0.2- μm filter. However, conventional filter plates have a short nozzle, which causes the sample to splash, and there is concern about contamination of other wells. The FastRemover MF has a long nozzle that enters each well, allowing the sample to be filtered with minimal risk of contamination.

LC/MS Analysis Result of Post-Filtration Eluate

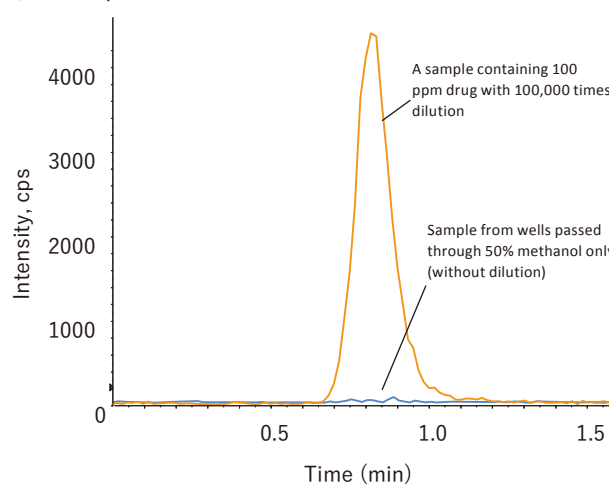

Filter Plate for Deproteinization FastRemover for Protein

The deproteinization method requires a significant amount of time and effort when processing multiple samples. In processing with FastRemover for Protein, the sample is easily recovered by the pass-through filtration of the protein-denatured sample using an organic solvent and aspiration. FastRemover for Protein uses polypropylene pellets, which have low plasticizer elution, and the membrane is molded from PTFE, which exhibits a low adsorption capacity, into a multilayer membrane. Thus, it can be used with any denaturing agent, from methanol to acetonitrile.

Filter Plate for Phospholipids/Pro

Biological samples, such as blood, contain phospholipids. In LC/mass spectrometry (MS) (/mass spectrometry (MS)) analysis, these phospholipids may suppress the ionization of the target substance.

FastRemover for phospholipids removes more than 90% of phospholipids for more accurate analysis.



Specification

| Description | Specification |
|------------------------|---|
| Pore Size | 0.2 µm |
| Max. Throughput Volume | 1.0 mL |
| Recommended Solvent | 0.1 to 1% Formic Acid-Acetonitrile Solution 1:4 or 1:3 (Biological sample:Solvent) |
| Max. Sample Capacity | 150 µL (Serum) |

Fast Remover Series Specification

| Description | Specification |
|---------------------|-------------------|
| Material of Filter | PP, PE, PTFE |
| Pore Size | 0.2 µm or 0.45 µm |
| Material of Housing | PP |
| Number | 96 |
| Volume | 1 mL |
| Sterility | Non-Sterile |



Lineup

| Description | Pore Size | Qty. | Cat.No. |
|-------------------------|-----------|--------|------------|
| FastRemover MF | 0.2 µm | 50 pcs | 7510-11037 |
| | | 1 pc | 7820-11001 |
| FastRemover for Protein | 0.45 µm | 5 pcs | 7820-11005 |
| | | 1 pc | 7820-11011 |
| | 0.2 µm | 5 pcs | 7820-11015 |
| | | 1 pc | 7510-11021 |

Monolith Silica ~ New separation media that are neither particulate nor membrane ~

Silica monoliths are integral silica gels with uniform continuous pores and produced from ethyl silicate. Unlike the particle media, the silica monolith is shaped like a disk. Silica monoliths have high liquid permeability and large surface area as they have through pores and mesopores on their framework surface. Thus, this state of the art medium is becoming popular worldwide for its properties: high recovery, high performance of adsorption, and desorption.

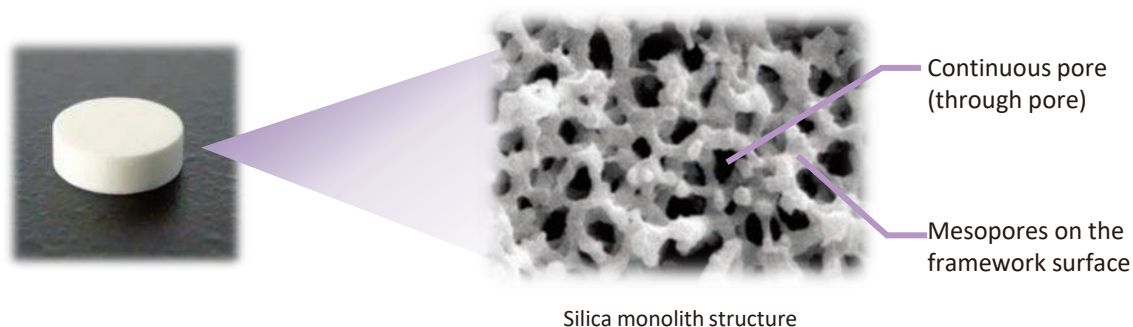

Advantages of Monolithic SPE materials over particle packed SPE materials

- Disk-shaped silica monoliths do not use frits to hold particle media in traditional solid phase extraction cartridges.
- Monolithic material has a massive surface area, making it possible to reduce the sample volume. Silica monoliths makes it possible to retain samples in the cartridge and completely elute small samples during processing.
- Despite its high liquid permeability, it is also suitable for fast elution without losing its high recovery as it achieves rapid sample diffusion and separation.

Silica monolith

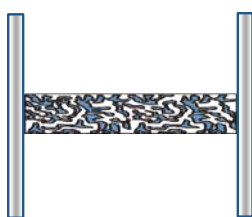

- No filter required
- Minimized separation media

Bed volume for separation media : **small**

Sample diffusion in the column : **fast**

Separation speed : **fast**

Particle-filled Form

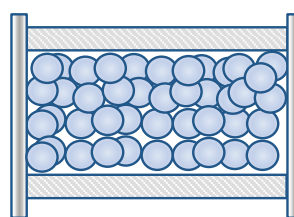

- Need for filters
→ liquid may be remained in the filter

Bed volume for separation media : **large**

Sample diffusion in the column : **slow**

Separation speed : **slow**

MonoSpin series

MonoSpin is a solid-phase extraction spin column that uses silica monoliths with uniform continuum pores. It effectively and rapidly extracts, isolates, purifies, and concentrates samples by centrifugation.

【Features】

- Easy operation by centrifuge
- Speedy sample treatment with a superb through the pore
- Excellent reproducibility (S-type) even at 100 μ L or fewer elution volumes.

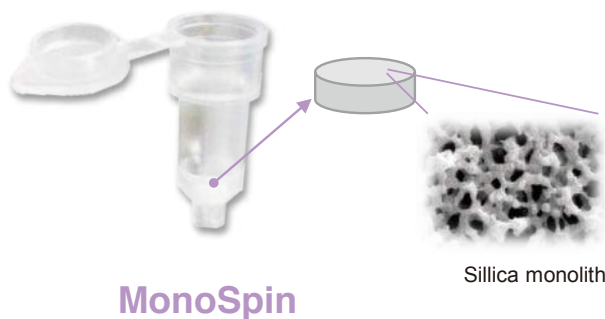

Operation method

Short time centrifugation is used to pass the liquid in solid-phase extraction.

The whole sample treatment process can be done within 10 min.

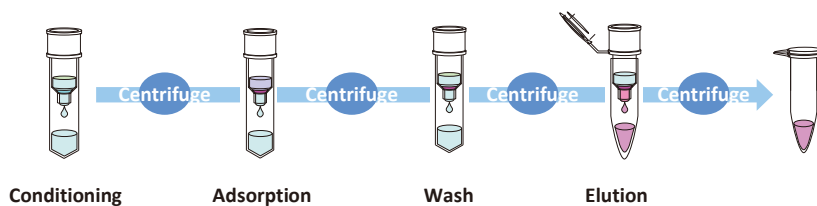

Centrifuge Operation

Shape

MonoSpin series cartridges of different types are available:

Type S: Excellent for pretreating the sample for 50–800 μ L

Type L: Appropriate for sample 0.5–8 mL.

For the details of the varied functional group, please see the next page.



S Type

- Disk size : 4.2 × 1.5 mm
- Sample volume : up to 800 μ L
- Elution volume : 50 to 800 μ L
- Centrifugation speed : 2,000 to 10,000 × g



L Type

- Disk size : 9 × 3 mm
- Sample volume : up to 8 mL
- Elution volume : 0.5 to 8 mL
- Centrifugation speed : 1,000 × g

NOTE) MonoSpin ProA and MonoSpin ProG have different shapes. Please see page 88 for details.

96 Well plate type

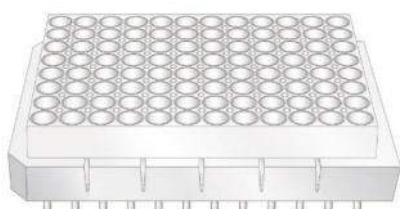

- Sample volume : up to 800 μ L
- Elution volume : 50 to 800 μ L
- Centrifugation speed : 1,000 to 5,000 × g (can be used in vacuum aspiration)

NOTE) MonoSpin C18 FF, MonoSpin ProA and MonoSpin ProG have different specifications. Please see page 82 and 83 for details.

MonoSpin series lineup

MonoSpin C18/C18 FF

S L 96

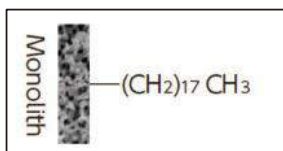

Octadecyl functional group. Optimal for drug extraction in biological samples and desalting and enrichment of peptide samples. High-flow (FF) designs are also available.

MonoSpin C18-AX

S 96

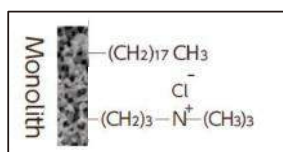

It is a mix mode type in which both octadecyl and quaternary ammonium groups are chemically bonded. It can reliably retain bio-samples at high salt concentrations and is particularly suitable for the recovery of acidic drugs.

MonoSpin SAX

S L 96

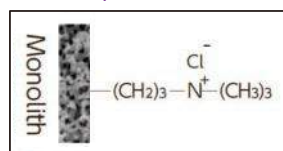

Bond with Trimethyl aminopropyl, combining strong anion exchange and weak hydrophobic interaction. It is best for extracting acidic drugs.

MonoSpin NH2

S L 96

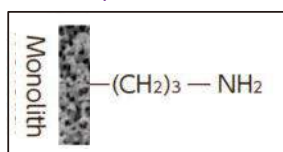

It is bonded with aminopropyl and is beneficial for enriching the sugar chain or hydrophilic compounds by HILIC mode.

MonoSpin Amide

S 96

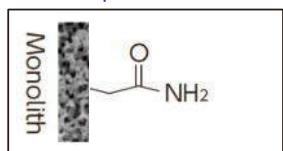

It is bonded with an amide group. MonoSpin amide is best for extracting sugar chains and various acidic and basic hydrophilic compounds by HILIC mode.

MonoSpin TiO

S

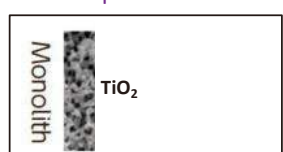

It is characterized by a monolith skeleton coated with dioxide titanium. It is excellent for enriching phosphopeptides.

MonoSpin ME

S L

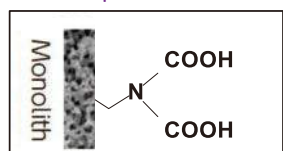

It is bonded with iminodiacetic acid groups. Therefore, it is optimal for the recovery of trace metals in samples.

MonoSpin ProA, ProG, ProL

S L 96

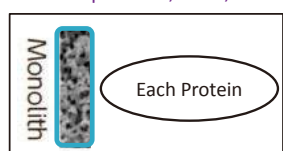

They are affinity carriers on which each protein is immobilized. Antibodies can be purified quickly. MonoSpin ProL is S type only. The shape of the L-shaped column is a syringe barrel type.

MonoSpin Ph

S

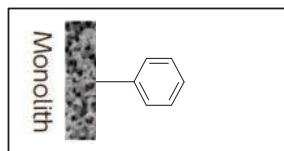

The phenyl group is chemically bonded, which makes it feasible to use weaker hydrophobicity than C18. Therefore, it is suitable for the recovery of hydrophobic drugs from biological samples under reversed phase mode.

MonoSpin C18-CX

S 96

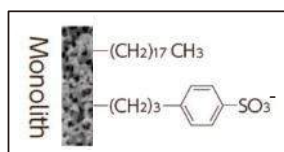

Its octadecyl and benzenesulfonic acid groups are bonded. Thus, purifying dissociated basic drugs in serum and urine is appropriate. Compared with MonoSpin C18 and SCX alone, SCX has higher cleanup efficacy as it works as hydrophobic and ion-exchange interactions.

MonoSpin SCX

S L 96

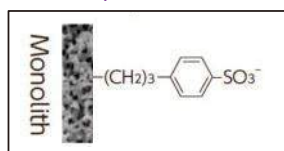

It is bonded with propyl benzene sulfonic acid, combining strong cation exchange and hydrophobic interaction. Therefore, MonoSpin SCX is excellent for extracting basic drugs.

MonoSpin CBA

S L 96

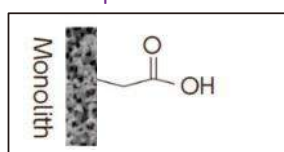

It is bonded with propyl benzene sulfonic acid, combining strong cation exchange and hydrophobic interaction. It is excellent for extracting basic drugs.

MonoSpin PBA

S 96

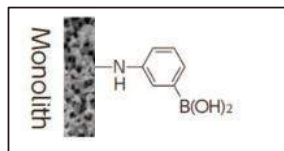

It is bonded with phenyl boric acid, which gives you higher selectivity. Hence, MonoSpin PBA is excellent for extracting cis diol compounds, such as catechol amines.

MonoSpin Trypsin

S



The columns are immobilized with trypsin, a digestive protein enzyme. It enables the rapid digestion of proteins.

MonoSpin Phospholipid

S L

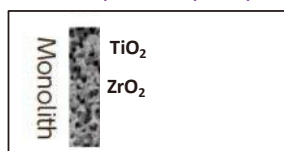

It has a phospholipid removal column coated with titanium dioxide and zirconium dioxide on a silica monolith. It adsorbed phospholipids in samples with an easy pretreatment.

MonoSpin AG

S L 96

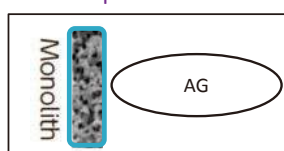

It is a column that combines octadecyl groups and cation exchange groups. Hydrophobic interaction and ion exchange action work.

S : S-type column products L : L-type column products 96 : 96-well plate-type product

Order Information

MonoSpin type S

| Description | Qty.(pcs) | Cat.No. |
|-----------------------|-----------|------------|
| MonoSpin C18 | 50 | 5010-21700 |
| | 100 | 5010-21701 |
| MonoSpin C18 FF | 50 | 5010-21670 |
| | 100 | 5010-21671 |
| MonoSpin Ph | 50 | 5010-21733 |
| | 100 | 5010-21734 |
| MonoSpin C18-AX | 50 | 5010-21735 |
| | 100 | 5010-21736 |
| MonoSpin C18-CX | 50 | 5010-21731 |
| | 100 | 5010-21732 |
| MonoSpin SAX | 50 | 5010-21720 |
| | 100 | 5010-21721 |
| MonoSpin SCX | 50 | 5010-21725 |
| | 100 | 5010-21726 |
| MonoSpin NH2 | 50 | 5010-21710 |
| | 100 | 5010-21711 |
| MonoSpin CBA | 50 | 5010-21729 |
| | 100 | 5010-21730 |
| MonoSpin Amide | 50 | 5010-21727 |
| | 100 | 5010-21728 |
| MonoSpin PBA | 50 | 5010-21715 |
| | 100 | 5010-21716 |
| MonoSpin TiO | 50 | 5010-21705 |
| | 100 | 5010-21706 |
| MonoSpin Trypsin HP | 30 | 7510-11302 |
| MonoSpin ME | 50 | 5010-21737 |
| | 100 | 5010-21738 |
| MonoSpin Phospholipid | 50 | 5010-21698 |
| | 100 | 5010-21699 |
| MonoSpin AG | 50 | 5010-21696 |
| | 100 | 5010-21697 |



MonoSpin Type S

Recovery tube
(1.7 mL)Liquid waste tube
(2 mL)

MonoSpin type S Trial kit

Trial and custom kits are shipped with various columns packaged for initial method development.

| Description | Content | Cat.No. |
|----------------------|------------------------------|------------|
| MonoSpin Trial Kit 1 | C18, TiO, SCX, SAX 10 each | 5010-21740 |
| MonoSpin Trial Kit 2 | C18, Amide, CBA, NH2 10 each | 5010-21741 |
| MonoSpin Trial Kit 3 | SCX, SAX, CBA, NH2 10 each | 5010-21742 |

MonoSpin type L

| Description | Qty.(pcs) | Cat.No. |
|-------------------------|-----------|------------|
| MonoSpin L C18 | 30 | 7510-11320 |
| MonoSpin L SAX | 30 | 7510-11321 |
| MonoSpin L SCX | 30 | 7510-11322 |
| MonoSpin L NH2 | 30 | 7510-11323 |
| MonoSpin L CBA | 30 | 7510-11324 |
| MonoSpin L ME | 30 | 7510-11325 |
| MonoSpin L Phospholipid | 30 | 7510-11326 |



MonoSpin type L

MonoSpin 96 well plate

| Description | Qty.(pcs) | Cat.No. |
|----------------------|-----------|------------|
| MonoSpin 96WP C18 | 1 | 5010-21900 |
| MonoSpin 96WP NH2 | 1 | 5010-21901 |
| MonoSpin 96WP PBA | 1 | 5010-21902 |
| MonoSpin 96WP SAX | 1 | 5010-21903 |
| MonoSpin 96WP SCX | 1 | 5010-21904 |
| MonoSpin 96WP Amide | 1 | 5010-21905 |
| MonoSpin 96WP CBA | 1 | 5010-21906 |
| MonoSpin 96WP C18-CX | 1 | 5010-21907 |
| MonoSpin 96WP C18-AX | 1 | 5010-21908 |

SPE Tip Columns for Trace Samples

MonoTip C18



MonoTip C18

MonoTip C18

MonoTip C18 is a pretreatment tip consisting of octadecyl groups bonded to silica monoliths with uniform continuous pores. Simple pipetting allows for the desalting and concentration of proteins and peptides in reversed-phase mode.

High purification efficiency, large loadings, good reproducibility.

With conventional tips that use particle fillers, it is difficult to keep the particle space constant, resulting in poor reproducibility and low recovery rates. However, by exploiting the monolith with uniform continuous pores, a high purification efficiency, large sample loadings, and good reproducibility can be achieved.

Effective sample concentration

Sample: β -casein trypsin digestible (0.1 mg/mL)

Condition
 Column : Inertsil WP300 C18
 (150 X 2.1 mm I.D.)
 Eluent : A: H₂O (0.1 %TFA)
 B: CH₃CN/H₂O=90/10
 (0.1 %TFA)
 A/B = 90/10-20 min-40/60
 Flow rate : 0.3 mL/min
 Detection : UV210 nm
 Injection Vol. : 5 μ L

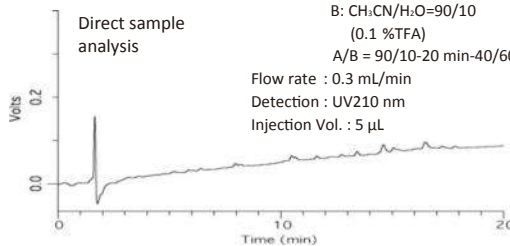

Preparation with MonoTip C18

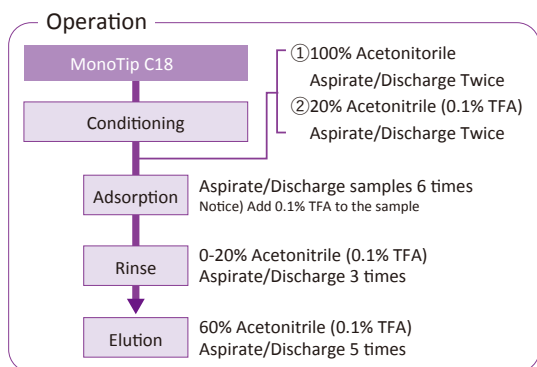
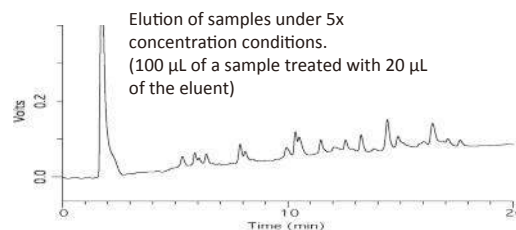

Purifications of antihistamine in serum

- "Simultaneous determination of ten antihistamine drugs in human plasma using pipette tip solid-phase extraction and gas chromatography/mass spectrometry." Hasegawa C et al., *Rapid Commun. Mass Spectrom* (2006);20: 537-543
- "Rapid demonstration of diversity of sulfatide molecular species from biological materials by MALDI-TOF/MS" Kyogashima M et al., *Glycobiology* (2006); 16(8),719-728
- "Simultaneous determination of methamphetamine and amphetamine in human urine using pipette tip solid-phase extraction and gas chromatography/mass spectrometry." Kumazawa T. et al. *J Pharm Biomed Anal.* 2007 Jan 8;
- "Establishment of a quantitative, qualitative, and high-throughput analysis of sulfatides from small amounts of sera by matrix-assisted laser desorption ionization-time of flight mass spectrometry." Li G et al *Anal Biochem.* 2007 Mar 1;362(1):1-7

| Description | Volume | Qty.(pcs) | Cat.No. |
|-------------|-------------|-----------|------------|
| MonoTip C18 | 200 μ L | 24 | 5010-21002 |
| | | 96 | 5010-21000 |

Note: MonoTip C18 is a product based on patent-registered technology.

EVSecond

Exosome Purification Columns

Recent studies have reported significant roles of extracellular vesicle “Exosome” in development and progression of various diseases including cancer metastasis. Therefore, exosomes are considered as important targets for biomarkers and drugs. However, it remains difficult to isolate high-purity exosomes from biological fluids such as serum. EVSecond is a size exclusion chromatography open column optimized for effective purification of exosomes. Highly-purified exosomes can be easily collected from serum, plasma, or cell culture supernatant.

Features

- Simple gravity-flow handling without ultracentrifugation.
- EVSecond-purified exosomes possess efficient purity for comprehensive miRNA, proteome, and metabolome analysis.
- Exosomes are gently eluted in PBS without structural damage, allowing re-administration experiments of collected exosomes to cells or animals.

Advantages Over Traditional Procedures

- Much higher-purity exosomes can be obtained compared to ultracentrifugation or polymer precipitation methods.
- Unlike immuno-affinity purification using anti-tetraspanin antibodies, whole exosomes can be collected regardless of surface antigen profiles.

Typical Protocol using EVSecond

Gravity-flow is applied to each step.

1. Set columns on GL-SPE EXO fraction rack after mixing beads gently and thoroughly.



2. Block beads with 0.22 µm filter-purified FBS.



3. Equilibrate columns with PBS.



4. Load 50-700 µL 0.22 µm filter-purified samples (serum, plasma, or cell culture supernatant).



5. Load PBS and collect appropriate fractions including exosomes.

* Exosome-containing fractions can be identified by western blotting or ELISA experiments detecting tetraspanins (CD9, CD63, CD81, etc.)

GL-SPE EXO Fraction Rack

Open column rack optimized for EVSecond.
It helps smooth column handling and fractionation.

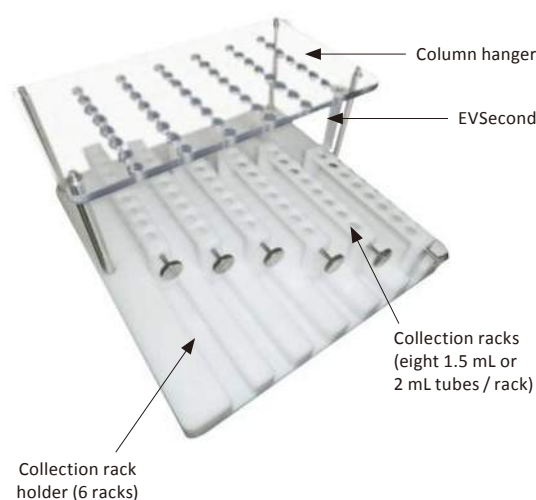

Dimensions : 300 (W) x 300 (D) x 150 (H) mm

Purification of Exosomes from Human Serum

A large amount of free proteins, metabolites, and nucleotides are involved in serum samples. Insufficient purification of exosomes often causes co-detection of non-exosomal components, leading to incorrect quantification results in omics studies. Exosomes were isolated from 100, 200, 300, or 700 μL of human serum using EVSecond method. Exosomes were clearly separated from serum free proteins such as albumin or immunoglobulins.

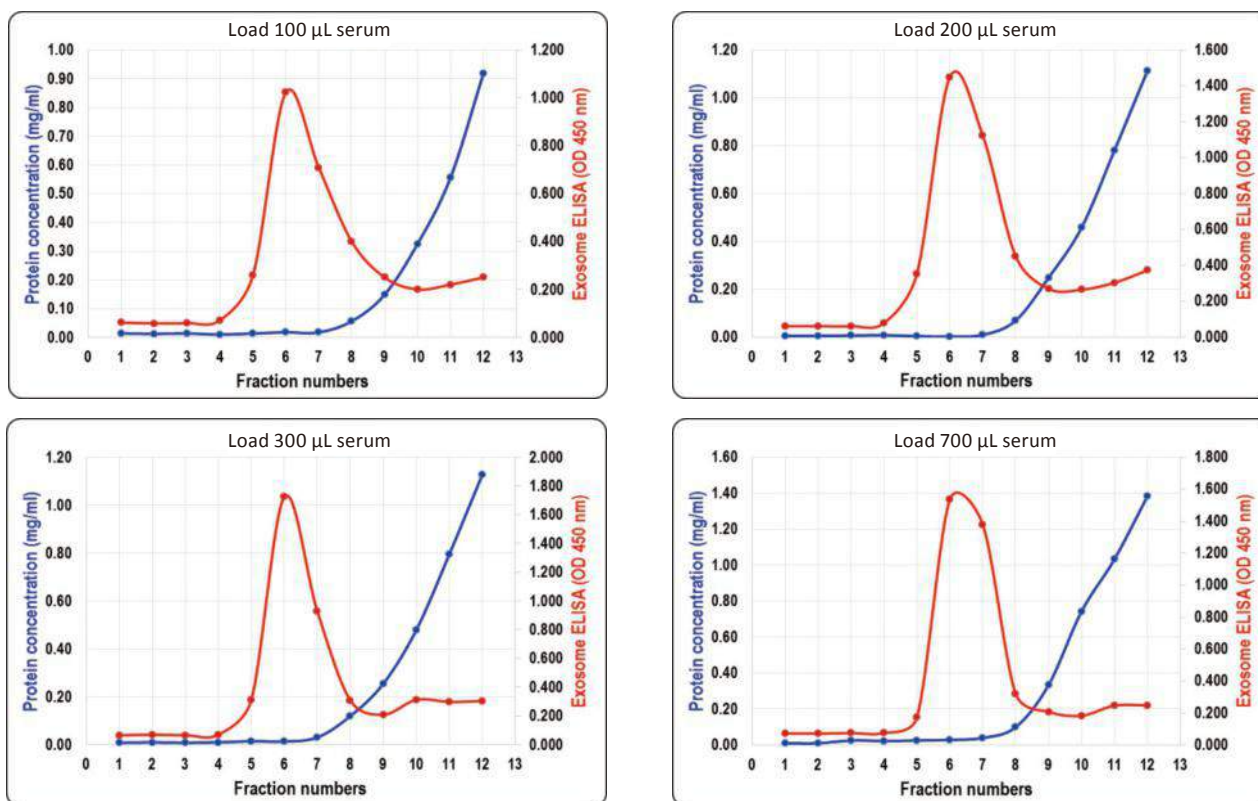

(100 μL / fraction)

Red line : CD9-CD9 exosome sandwich ELISA (detecting exosomes)

Blue line : Bradford assay (detecting serum free proteins)

Data provided by Dr. Koji Ueda from Graduate School of Frontier Sciences, The University of Tokyo

EVSecond

| Description | Qty. | Cat.No. |
|--------------------------|--------|------------|
| EVSecond L70 | 10 pcs | 5010-21395 |
| GL-SPE EXO Fraction Rack | 1 set | 5010-50450 |

EVSecond was developed based on the cooperation from Dr. Koji Ueda from Graduate School of Frontier Sciences, The University of Tokyo.

MonoSpin ProA, MonoSpin ProG, MonoSpin ProL

3

Products Related Life Sciences Analysis

MonoSpin ProA, MonoSpin ProG, MonoSpin ProL

MonoSpin ProA, MonoSpin ProG and MonoSpin ProL are already immobilized onto a silica monolith offering rapid purification of antibodies. Additionally, a 96-well plate format is available to purify a multi-analyte. Each reagent for the purification of samples is attached.



【Shapes】

Spin Column Type



- Purification with compact tabletop centrifuge just in two minutes (e.g., 2,300 × g)
 - Appropriate for purification of small volume sample (approximately 0.4 mg)
- Maximum sample volume : 500 μ L
Elution volume : 50 μ L Sample
loading capacity : ProA 400 μ g, ProG 300 μ g, ProL 200 μ g

96 Well plate Type



- Purification by both aspiration or centrifuge
 - Available for a multi-analyte with the same spin column volume.
- Maximum sample volume : 500 μ L
Elution volume : 50 μ L Sample
loading capacity : ProA 400 μ g, ProG 300 μ g

Large Spin Column



- Maximum 16 mg antibody can be recovered by centrifuge.
- Maximum sample volume : 8 mL
Elution volume : 2 mL Sample
loading capacity : ProA 16 mg, ProG 12 mg

MonoSpin ProA, MonoSpin ProG, MonoSpin ProL

| Description | Qty.(pcs) | Cat.No. |
|-----------------------------|-----------|------------|
| MonoSpin ProA column | 10 | 7510-11310 |
| MonoSpin ProG column | 10 | 7510-11311 |
| MonoSpin ProL column | 6 | 7510-11317 |
| MonoSpin ProA 96 well plate | 1 | 7510-11312 |
| MonoSpin ProG 96 well plate | 1 | 7510-11313 |
| MonoSpin L ProA | 4 | 7510-11314 |
| MonoSpin L ProG | 4 | 7510-11315 |
| MonoSpin ProA/G buffer kit | - | 7510-11316 |

Phosphorylated Protein Research

The study of reversible phosphorylation plays an important role in elucidating many cellular phenomena, including cell cycle, cell growth, apoptosis, and differentiation. However, when analyzing phosphopeptides in proteins, there are cases in which phosphopeptides are difficult to detect by MS because of their small amounts and low ionization efficiency. To solve this problem, GL Sciences offers the Titansphere series, which is optimized for the purification and concentration of phosphopeptides using titanium dioxide (titania) to specifically adsorb phosphopeptides.

Adsorption Mechanism

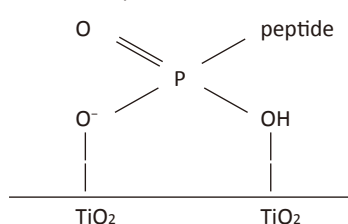

● Principle

- It is believed that phosphate groups and titanium dioxide adsorb under acidic conditions.
- Various studies have shown that titania and phosphopeptides bind selectively to each other. Evaluating the performance of titania optimized for the purification and concentration of phosphopeptides and the stability achieved only by in-house synthesis.

Titansphere TiO Bulk Materials (Titania Dioxide)

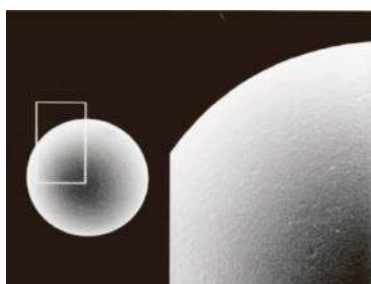

Titania Bulk Material

Titansphere TiO is a high-performance bead made of titania (titanium dioxide: TiO₂) synthesized into uniform porous spherical particles that can selectively concentrate and purify phosphopeptides.

● Specification

| Description | Specification |
|-----------------|--------------------------|
| Particle Size | 5 μm, 10 μm |
| Particle Shape | Spherical |
| Adsorption Spot | Titanium Dioxide Crystal |
| Pore Size | 100 Å |
| pH Range | 2 ~ 12 |
| Gravity | 1.74 |

Note: This filler was developed with the cooperation of Dr. Hiroshi Nakamura, who was affiliated with the Faculty of Pharmaceutical Sciences, Tokyo University of Science at the time of product development.

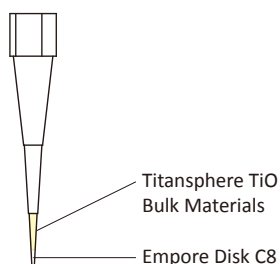

How to make a Titania Column

- (1) Put an Empore Disk C8 cut to an appropriate size in the tip of the tip for 200 μL and use it as a filter.
- (2) Titansphere TiO filler is stirred with CH₃CN/H₂O = 80/20 (v/v) and loaded into the tip. (Fill volume should be changed according to the purpose).
- (3) Pressurize with air from the top of the tip using a syringe.

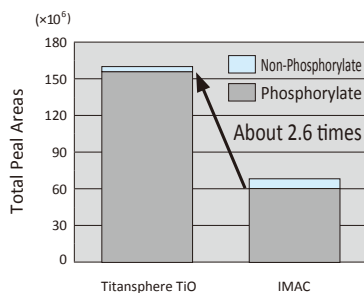

Comparison of Phosphorylated Peptide Recovery Amount

Compare Titansphere TiO with IMAC

Arabidopsis cell extracts were used to conduct a comparison study with commercial IMAC. Compared with IMAC, a high amount of phosphorylated peptides was detected, with a 2.6-fold increase in the total peak area of phosphorylated peptides and a 1.8-fold increase in the peptide identification constant.

| Description | Specification | Volume | Cat.No. |
|-----------------|---------------|--------|------------|
| Titansphere TiO | 5 μm | 500 mg | 5020-75000 |
| | 10 μm | 500 mg | 5020-75010 |

Titansphere Phos-TiO Kit



Tip Column

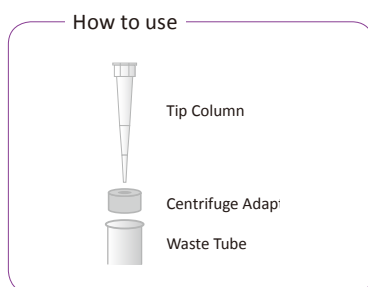

This kit includes a chip column, dedicated buffer, and protocols. The chip columns are optimized for the Phos-TiO Kit to enhance the adsorption capacity and the efficient purification and concentration of phosphopeptides. The Phos-TiO MP kit is also suitable for the purification and enrichment of multiple phosphorylated peptides.

● Specification

| Sorbent Mass/Tip Volume | 1 mg/10 µL | 3 mg/200 µL |
|-------------------------|------------|-------------|
| Sample Loading Capacity | 1.2 µg | 3.5 µg |

Sample: Tyr(PO₃H₂)-Angiotensin II

● Features

- High selectivity
Due to its high affinity toward peptides containing phosphate groups, phosphopeptides can be detected by MS even in unstimulated cell extracts containing small amounts of phosphopeptides.
- Easy operation
The operation process consists of only five steps. It can be purified and concentrated in a short time, with an operation time of approximately 40 min. In addition, each step is performed entirely by centrifugation. Therefore, human error is minimized, and the system can be easily operated by anyone.
- Small–large numbers of samples can be handled.
Since the chip column is a stand-alone unit, experiments can be performed from one sample to many samples at once using a dedicated centrifugal adapter (sold separately).

| Description | Sorbent Mass/Tip Volume | Qty. | Cat.No. |
|----------------------------|-------------------------|----------|------------|
| Titansphere Phos-TiO Kit | 1 mg/10 µL | 24 Times | 5010-21300 |
| | 3 mg/200 µL | 24 Times | 5010-21305 |
| | 3 mg/200 µL | 96 Times | 5010-21306 |
| TitanspherePhos-TiO MP kit | 1 mg/200 µL | 24 Times | 5010-21280 |
| | 3 mg/200 µL | 24 Times | 5010-21281 |

Note: A centrifugal adapter is required for operation. Please purchase separately.



Centrifuge Adapter

| Description | Sorbent Mass/Tip Volume | Qty. | Cat.No. |
|--------------------------|-------------------------|--------|------------|
| Titansphere Phos-TiO Tip | 1 mg/10 µL | 24 pcs | 5010-21302 |
| | | 96 pcs | 5010-21303 |
| | 1 mg/200 µL | 24 pcs | 5010-21316 |
| | | 96 pcs | 5010-21317 |
| | 3 mg/200 µL | 24 pcs | 5010-21307 |
| | | 96 pcs | 5010-21308 |



For 10 µL Tip
96WP Centrifuge Adapter



For 200 µL Tip
96WP Centrifuge Adapter

| Description | Particle Size | Qty. | Cat.No. |
|---------------------------|---------------|--------|------------|
| Titansphere Phos-TiO Bulk | 10 µm | 500 mg | 5010-21315 |

| Description | Sorbent Mass/Tip Volume | Qty. | Cat.No. |
|-------------------------|-------------------------|--------|------------|
| Centrifuge Adapter | 10 µL, 200 µL | 24 pcs | 5010-21514 |
| 96WP Centrifuge Adapter | 10 µL | 1 pc | 5010-21340 |
| | 200 µL | 1 pc | 5010-21341 |

Phosphorylation Purification & Enrichment

3

Products Related Life Sciences Analysis

Titansphere Phos-TiO



A syringe-barrel type cartridge column is used for the selective collection and concentration of phosphorylated peptides with a larger loading capacity than that of the tip type.

From conditioning to elution, the process can be performed in a centrifuge. This reduces human error and makes it easy for anyone to operate.

| | | |
|-------------------------|------------|-------------|
| Sorbent Mass/Tip Volume | 50 mg/3 mL | 100 mg/3 mL |
| Particle Size | 10 μm | |
| Sample Loading Capacity | 60 μg | 120 μg |

Note: The loading volume is a guide when Tyr (PO₃H₂)-Angiotensin II is used. The maximum sample load varies depending on the state of the matrix.

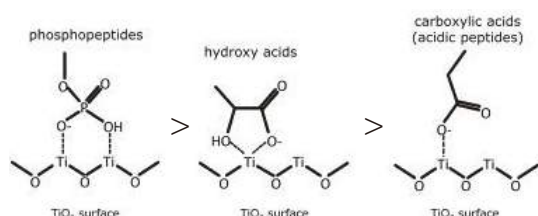

Principle

Titanium dioxide is thought to adsorb with high affinity for phosphate groups. However, our recommended purification method using a lactic acid solution (hydroxy acid) prevents the adsorption of non-phosphorylated peptides because the lactic acid binds to the remaining active sites and inhibits the binding of the carboxyl groups.

How to Operate

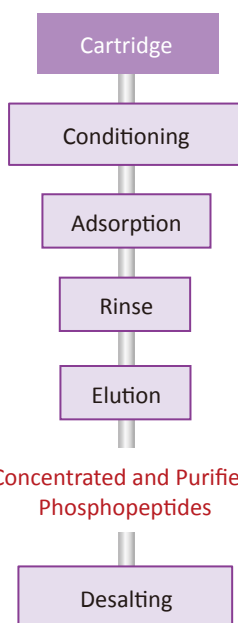

From conditioning to elution, various solutions and samples are passed through a centrifuge. (Conditioning and elution solutions are listed as examples).

Note: Due to the small particle size, purification and concentration cannot be performed using a suction manifold.

Add Buffer A: 80 % Acetonitrile (0.5 % TFA), then centrifuge
Add Buffer B: 300 mg/mL of Lactic acid in Buffer A, then centrifuge

Add 5 % ammonium aqueous solution, then centrifuge.
Add 5 % pyrrolidine aqueous solution, then centrifuge

MonoSpin C18 is recommended for desalting. (Page 128)
For more information on desalination, please contact us separately.

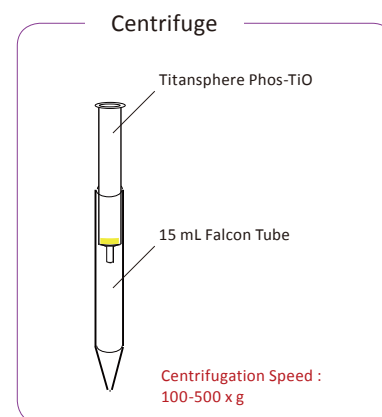

| Description | Sorbent Mass/Tip Volume | Qty.(pk unit) | Cat.No. |
|--|-------------------------|---------------|------------|
| Titansphere Phos-TiO | 50 mg/3 mL | 25 pcs(1 pc) | 5010-21290 |
| | 100 mg/3 mL | 25 pcs(1 pc) | 5010-21291 |
| Description | Volume | Cat.No. | |
| Lactic Acid for Titansphere Phos-TiO 3mL Cartridge | 15 mL | 5010-21295 | |

Tip Columns for Enrichment of Phosphopeptides

MonoTip TiO

MonoTip TiO is a pretreatment tip consisting of a matrix silica gel coated with titanium dioxide that selectively collects phosphopeptides.

Using MonoTip TiO to collect only phosphorylated peptides, the detection sensitivity can be improved, and the time required for analysis can be reduced



● Features

- Peptides can be easily purified by pipetting. Unlike the case in the IMAC method, no metal coordination bonding process is required here, and there is no metal dropout.
- Sample volume: 50–200 μL . Each chip can hold $\sim 5 \mu\text{g}$ of phosphopeptide and can be concentrated by reducing the eluate.

Apprication

Sample : β -Casein

1 phosphopeptide : FQpSEEQQTEDELQDK(MW=2061)

4 phosphopeptides: RFLEELNVPGEIVEpSLpSpSpSpSEESLTR(MW=3122)

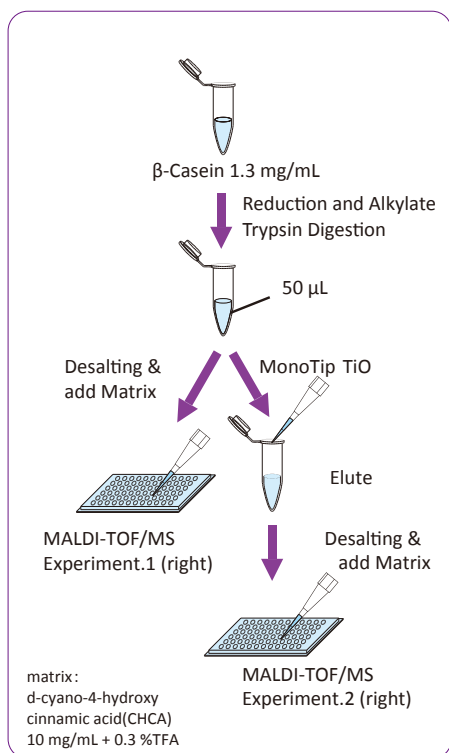

Experiment 1: Sample before purification (phosphorylated peptides are barely detectable)

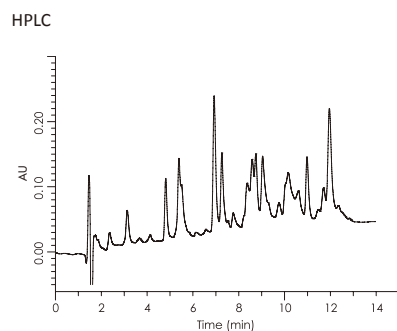

Many types of digests are observed

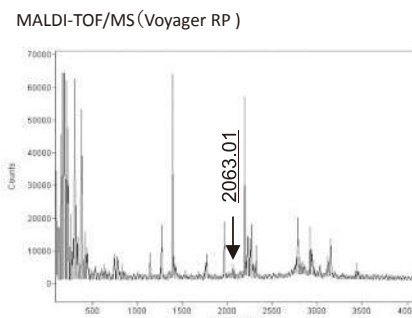

Detects only monophosphorylated peptides

Experiment 2: Post-purification sample (can be selectively extracted from many peptides)

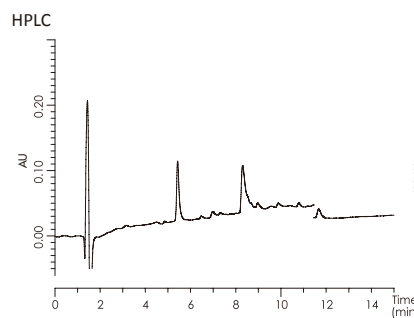

Only two types of digests are observed. Purification effect by MonoTip will be confirmed.

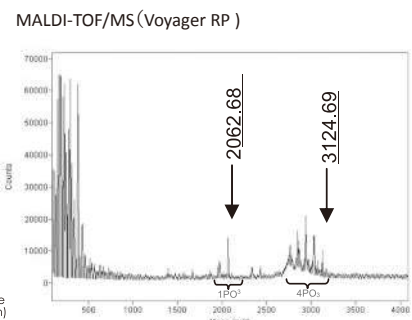

Phosphorylated peptides and tetraphosphorylated peptides in significant amounts are detected.

Specification

| Description | Specification |
|------------------------|------------------------|
| Operation time | Approx. 6 mins |
| Suitable sample volume | 20 ~ 200 μL |
| Sample loading volume | $\sim 5 \mu\text{g}$ |
| Tip volume | 200 μL |

| Description | Specification |
|-----------------------|--|
| Packing material | Silica Monolith (Highly pure silica gel) |
| Through-pore Diameter | 10 ~ 20 μm |
| Meso-pore Diameter | 20 nm |
| Surface area | 200 m^2/g |
| Functional group | Dioxide titan coating |

| Description | Volume | Qty. | Cat.No. |
|-------------|-------------------|--------|------------|
| MonoTip TiO | 200 μL | 24 pcs | 5010-21007 |
| | | 96 pcs | 5010-21005 |

GL-Tip Series

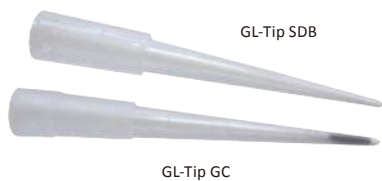

How to operate

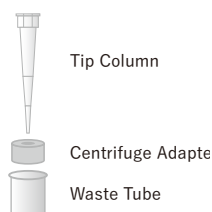

Prepare a centrifuge capable of operating at 3000 x g.

Peptide Desalting and Enrichment Tip

GL-Tip SDB is a 200- μ L tip filled with SDB (styrene divinylbenzene) polymer. Trapping with SDB chips, which have even stronger retention than C18 (silica matrix), reduces the peptide loss and enables efficient desalting.

The GL-Tip GC packed with GC can trap highly hydrophilic peptides and can be used in conjunction with the GL-Tip SDB to improve peptide identification.

Spin Tips for Peptide Fractionation GL-Tip SCX / GL-Tip SDB-SCX

GL-Tip SCX is a chip filled with SCX (cation-exchange resin), and GL-Tip SDB-SCX is a chip combining the SDB (styrene divinyl benzene) polymer and SCX.

The GL-Tip SDB-SCX can perform desalting in the first stage of SDB, allowing the direct handling of salt-containing samples.

Comparison of salinity gradient and TFA gradient methods

Conventionally, peptide fractionation is performed by elution using a salt-concentration gradient; however, the same peptides are often mixed in the fractions before and after, resulting in inefficiency due to the identification of the same peptides. However, the use of a more efficient TFA gradient method (patent pending), which is an improvement over the salinity gradient method, is expected to improve the peptide identification constant and efficiency. The GL-Tip SCX is a chip optimized for the TFA gradient method.

Its fractionation efficiency was tested using phosphorylated peptides derived from human colon cancer DLD-1 established cells. The TFA gradient method identified 14,307 peptides with the same constant, indicating high efficiency. In addition, few overlapping peptides were observed in the eluate, allowing for efficient identification.

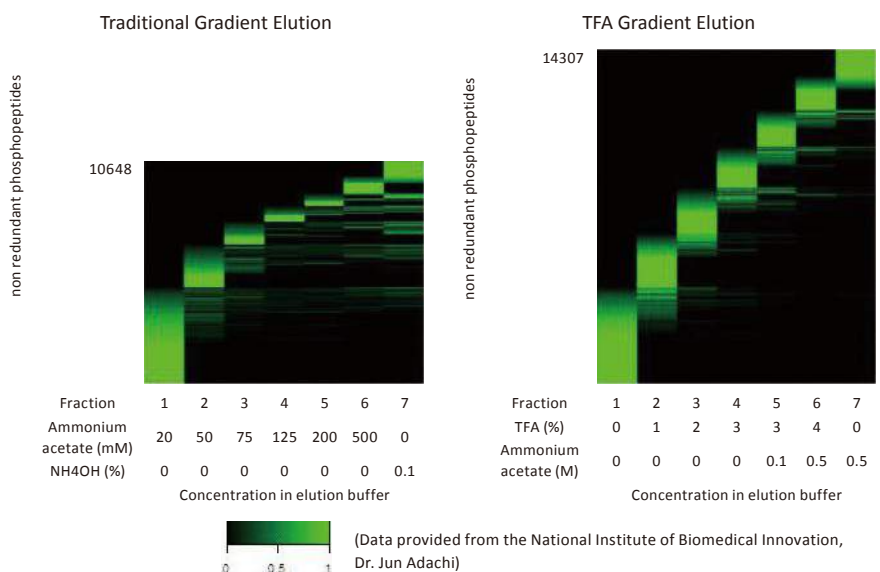

| Description | Volume | Sample Loading Capacity (Reference) | Qty. | Cat.No. |
|--------------------|-------------------------------|-------------------------------------|--------|------------|
| GL-Tip SDB | 200 μ L | 60 μ g | 96 pcs | 7820-11200 |
| GL-Tip GC | 200 μ L | 30 μ g | 96 pcs | 7820-11201 |
| GL-Tip SDB-SCX | 200 μ L | 60 μ g | 96 pcs | 7510-11202 |
| GL-Tip SCX | 200 μ L | 60 μ g | 96 pcs | 7510-11203 |
| Centrifuge Adapter | For 10/200 μ L Tip Column | - | 24 pcs | 5010-21514 |

Note: GL-Tip SCX and SDB-SCX were developed in cooperation with Dr. Takeshi Asanaga and Dr. Jun Adachi of the National Institute of Biomedical Innovation, Health and Nutrition. GL-Tip SCX and SDB-SCX are products based on patent pending technology.

4. Cat.No. Index

Cat.No. Index

4

Cat.No. Index

1030

| | |
|--------|----|
| -55102 | 75 |
| -55105 | 75 |
| -55110 | 75 |
| -55120 | 75 |

3008

| | |
|--------|----|
| -41151 | 73 |
|--------|----|

5010

| | |
|--------|-------|
| -21000 | 85 |
| -21002 | 85 |
| -21005 | 93 |
| -21007 | 93 |
| -21280 | 91 |
| -21281 | 91 |
| -21290 | 92 |
| -21291 | 92 |
| -21295 | 92 |
| -21300 | 91 |
| -21302 | 91 |
| -21303 | 91 |
| -21305 | 91 |
| -21306 | 91 |
| -21307 | 91 |
| -21308 | 91 |
| -21315 | 91 |
| -21316 | 91 |
| -21317 | 91 |
| -21340 | 91 |
| -21341 | 91 |
| -21395 | 87 |
| -21514 | 91/94 |
| -21670 | 83 |
| -21671 | 83 |
| -21696 | 83 |
| -21697 | 83 |
| -21698 | 83 |
| -21699 | 83 |
| -21700 | 83 |
| -21701 | 83 |
| -21705 | 83 |
| -21706 | 83 |
| -21710 | 83 |
| -21711 | 83 |
| -21715 | 83 |
| -21716 | 83 |
| -21720 | 83 |
| -21721 | 83 |
| -21725 | 83 |
| -21726 | 83 |
| -21727 | 83 |
| -21728 | 83 |
| -21729 | 83 |
| -21730 | 83 |
| -21731 | 83 |
| -21732 | 83 |
| -21733 | 83 |
| -21734 | 83 |
| -21735 | 83 |
| -21736 | 83 |
| -21737 | 83 |
| -21738 | 83 |
| -21740 | 83 |
| -21741 | 83 |
| -21742 | 83 |
| -21900 | 84 |
| -21901 | 84 |

| | |
|--------|----|
| -21902 | 84 |
| -21903 | 84 |
| -21904 | 84 |
| -21905 | 84 |
| -21906 | 84 |
| -21907 | 84 |
| -21908 | 84 |
| -23500 | 61 |
| -23501 | 61 |
| -23510 | 61 |
| -23520 | 61 |
| -25020 | 13 |
| -25025 | 13 |
| -25030 | 13 |
| -25035 | 13 |
| -25036 | 13 |
| -25050 | 13 |
| -25051 | 13 |
| -25200 | 13 |
| -25205 | 13 |
| -25500 | 54 |
| -26020 | 13 |
| -27100 | 15 |
| -27101 | 15 |
| -27102 | 15 |
| -27103 | 15 |
| -27104 | 15 |
| -27105 | 15 |
| -27111 | 15 |
| -27113 | 15 |
| -27114 | 15 |
| -27205 | 16 |
| -27210 | 18 |
| -27215 | 24 |
| -27216 | 25 |
| -27235 | 17 |
| -27240 | 19 |
| -27300 | 16 |
| -27301 | 16 |
| -27302 | 16 |
| -27303 | 16 |
| -27304 | 16 |
| -27305 | 16 |
| -27306 | 16 |
| -27307 | 16 |
| -27319 | 17 |
| -27320 | 17 |
| -27321 | 17 |
| -27322 | 17 |
| -27323 | 17 |
| -27324 | 17 |
| -27325 | 17 |
| -27326 | 17 |
| -27327 | 17 |
| -27330 | 17 |
| -27331 | 17 |
| -27350 | 18 |
| -27351 | 18 |
| -27352 | 18 |
| -27353 | 18 |
| -27354 | 18 |
| -27355 | 18 |
| -27356 | 18 |
| -27357 | 18 |
| -27370 | 19 |
| -27371 | 19 |
| -27372 | 19 |
| -27373 | 19 |
| -27374 | 19 |
| -27375 | 19 |
| -27376 | 19 |

| | |
|--------|----|
| -27377 | 19 |
| -27400 | 24 |
| -27401 | 24 |
| -27402 | 24 |
| -27403 | 24 |
| -27404 | 24 |
| -27405 | 24 |
| -27406 | 24 |
| -27407 | 24 |
| -27410 | 25 |
| -27411 | 25 |
| -27412 | 25 |
| -27413 | 25 |
| -27414 | 25 |
| -27415 | 25 |
| -27416 | 25 |
| -27417 | 25 |
| -27430 | 13 |
| -27431 | 13 |
| -27520 | 12 |
| -27521 | 12 |
| -27522 | 12 |
| -27523 | 12 |
| -27524 | 12 |
| -27525 | 12 |
| -27532 | 12 |
| -27533 | 12 |
| -27534 | 12 |
| -27535 | 12 |
| -27536 | 12 |
| -27537 | 12 |
| -27538 | 12 |
| -27539 | 12 |
| -27540 | 12 |
| -27541 | 12 |
| -27556 | 21 |
| -27565 | 20 |
| -27566 | 20 |
| -27576 | 21 |
| -27591 | 20 |
| -27620 | 15 |
| -27621 | 15 |
| -27622 | 15 |
| -27623 | 15 |
| -27624 | 15 |
| -27625 | 12 |
| -27626 | 12 |
| -27630 | 16 |
| -27631 | 16 |
| -27632 | 16 |
| -27633 | 16 |
| -27634 | 16 |
| -27640 | 17 |
| -27641 | 17 |
| -27642 | 17 |
| -27643 | 17 |
| -27644 | 17 |
| -27645 | 17 |
| -27650 | 18 |
| -27651 | 18 |
| -27652 | 18 |
| -27653 | 18 |
| -27654 | 18 |
| -27660 | 19 |
| -27661 | 19 |
| -27662 | 19 |
| -27663 | 19 |
| -27664 | 19 |
| -27670 | 24 |
| -27671 | 24 |
| -27672 | 24 |

| | |
|--------|-------|
| -27673 | 24 |
| -27674 | 24 |
| -27681 | 25 |
| -27682 | 25 |
| -27683 | 25 |
| -27684 | 25 |
| -27810 | 59 |
| -27811 | 59 |
| -30250 | 14 |
| -33071 | 74 |
| -50014 | 67 |
| -50015 | 67 |
| -50016 | 67/69 |
| -50017 | 67 |
| -50018 | 67 |
| -50019 | 67 |
| -50020 | 67 |
| -50022 | 67 |
| -50024 | 67 |
| -50026 | 66 |
| -50027 | 66 |
| -50028 | 66 |
| -50029 | 66 |
| -50030 | 66 |
| -50032 | 67 |
| -50033 | 67 |
| -50040 | 66 |
| -50041 | 67 |
| -50122 | 67/69 |
| -50123 | 67 |
| -50124 | 67 |
| -50125 | 67 |
| -50127 | 67/69 |
| -50128 | 67 |
| -50129 | 67 |
| -50134 | 73 |
| -50150 | 74 |
| -50155 | 74 |
| -50160 | 74 |
| -50161 | 74 |
| -50162 | 74 |
| -50163 | 74 |
| -50165 | 74 |
| -50166 | 74 |
| -50167 | 74 |
| -50168 | 74 |
| -50169 | 74 |
| -50211 | 70 |
| -50212 | 66/70 |
| -50213 | 70 |
| -50214 | 70 |
| -50230 | 65 |
| -50233 | 65 |
| -50234 | 65 |
| -50235 | 65 |
| -50236 | 73 |
| -50237 | 67 |
| -50238 | 67 |
| -50239 | 67 |
| -50240 | 67/71 |
| -50241 | 67/71 |
| -50242 | 67/71 |
| -50243 | 67 |
| -50244 | 67 |
| -50246 | 67/71 |
| -50247 | 67 |
| -50249 | 67/71 |
| -50251 | 73 |
| -50252 | 73 |
| -50253 | 67/71 |
| -50254 | 67 |

| | | | | | | | |
|--------|-------------|--------|----|--------|----|--------|----|
| -50256 | 67/71/73 | -60156 | 68 | -61165 | 34 | -61400 | 41 |
| -50336 | 59/68 | -61000 | 26 | -61166 | 34 | -61401 | 41 |
| -50410 | 72 | -61001 | 26 | -61167 | 34 | -61402 | 41 |
| -50420 | 72 | -61002 | 26 | -61168 | 34 | -61403 | 41 |
| -50421 | 72 | -61003 | 26 | -61180 | 35 | -61404 | 41 |
| -50422 | 72 | -61004 | 26 | -61181 | 35 | -61405 | 41 |
| -50423 | 72 | -61005 | 26 | -61182 | 35 | -61406 | 41 |
| -50424 | 72 | -61006 | 26 | -61183 | 35 | -61407 | 41 |
| -50425 | 72 | -61007 | 26 | -61184 | 35 | -61408 | 41 |
| -50430 | 72 | -61008 | 26 | -61185 | 35 | -61420 | 43 |
| -50431 | 72 | -61009 | 26 | -61186 | 35 | -61421 | 43 |
| -50432 | 72 | -61010 | 26 | -61187 | 35 | -61422 | 43 |
| -50433 | 72 | -61011 | 26 | -61188 | 35 | -61423 | 43 |
| -50434 | 72 | -61012 | 26 | -61189 | 35 | -61424 | 43 |
| -50440 | 72 | -61013 | 26 | -61190 | 35 | -61425 | 43 |
| -50441 | 72 | -61014 | 26 | -61191 | 35 | -61426 | 43 |
| -50450 | 87 | -61015 | 26 | -61192 | 35 | -61427 | 43 |
| -51001 | 70 | -61016 | 26 | -61204 | 31 | -61428 | 43 |
| -51002 | 70 | -61020 | 28 | -61300 | 36 | -61440 | 44 |
| -51010 | 70 | -61021 | 28 | -61301 | 36 | -61441 | 44 |
| -51011 | 70 | -61022 | 28 | -61302 | 36 | -61442 | 44 |
| -51012 | 70 | -61023 | 28 | -61303 | 36 | -61443 | 44 |
| -51013 | 66/70 | -61024 | 28 | -61304 | 36 | -61444 | 44 |
| -51014 | 66/70 | -61025 | 28 | -61305 | 36 | -61445 | 44 |
| -51015 | 70 | -61026 | 28 | -61306 | 36 | -61446 | 44 |
| -51016 | 70 | -61027 | 28 | -61307 | 36 | -61447 | 44 |
| -51017 | 70 | -61028 | 28 | -61308 | 36 | -61448 | 44 |
| -51020 | 70 | -61040 | 29 | -61320 | 37 | -61453 | 44 |
| -51021 | 70 | -61041 | 29 | -61321 | 37 | -61500 | 45 |
| -51031 | 75 | -61042 | 29 | -61322 | 37 | -61501 | 45 |
| -51032 | 75 | -61043 | 29 | -61323 | 37 | -61502 | 45 |
| -51033 | 75 | -61044 | 29 | -61324 | 37 | -61503 | 45 |
| -51039 | 70 | -61045 | 29 | -61325 | 37 | -61504 | 45 |
| -51040 | 70 | -61046 | 29 | -61326 | 37 | -61505 | 45 |
| -51041 | 70 | -61047 | 29 | -61327 | 37 | -61506 | 45 |
| -51042 | 70 | -61048 | 29 | -61328 | 37 | -61507 | 45 |
| -52011 | 71 | -61049 | 29 | -61329 | 37 | -61508 | 45 |
| -52012 | 71 | -61050 | 29 | -61330 | 37 | -61509 | 45 |
| -52013 | 71 | -61051 | 29 | -61331 | 37 | -61510 | 45 |
| -52015 | 75 | -61052 | 29 | -61332 | 37 | -61511 | 45 |
| -52016 | 75 | -61080 | 32 | -61340 | 38 | -61520 | 46 |
| -52021 | 75 | -61081 | 32 | -61341 | 38 | -61521 | 46 |
| -52022 | 75 | -61082 | 32 | -61342 | 38 | -61522 | 46 |
| -60000 | 59/66/68 | -61083 | 32 | -61343 | 38 | -61523 | 46 |
| -60001 | 59/68 | -61084 | 32 | -61344 | 38 | -61524 | 46 |
| -60002 | 59/68 | -61085 | 32 | -61345 | 38 | -61525 | 46 |
| -60004 | 59/68 | -61086 | 32 | -61346 | 38 | -61526 | 46 |
| -60010 | 66/67/69/72 | -61087 | 32 | -61347 | 38 | -61527 | 46 |
| -60015 | 59/69 | -61088 | 32 | -61348 | 38 | -61528 | 46 |
| -60016 | 59/69 | -61089 | 32 | -61349 | 38 | -61529 | 46 |
| -60017 | 59/69 | -61090 | 32 | -61350 | 38 | -61540 | 47 |
| -60100 | 68 | -61091 | 32 | -61351 | 38 | -61541 | 47 |
| -60101 | 68 | -61092 | 32 | -61352 | 38 | -61542 | 47 |
| -60102 | 68 | -61120 | 33 | -61360 | 40 | -61543 | 47 |
| -60103 | 68 | -61121 | 33 | -61361 | 40 | -61544 | 47 |
| -60104 | 68 | -61122 | 33 | -61362 | 40 | -61545 | 47 |
| -60105 | 68 | -61123 | 33 | -61363 | 40 | -61546 | 47 |
| -60106 | 68 | -61124 | 33 | -61364 | 40 | -61547 | 47 |
| -60120 | 68 | -61125 | 33 | -61365 | 40 | -61548 | 47 |
| -60121 | 68 | -61126 | 33 | -61366 | 40 | -61549 | 47 |
| -60122 | 68 | -61127 | 33 | -61367 | 40 | -61550 | 47 |
| -60123 | 68 | -61128 | 33 | -61368 | 40 | -61551 | 47 |
| -60124 | 68 | -61129 | 33 | -61380 | 42 | -61552 | 47 |
| -60125 | 68 | -61130 | 33 | -61381 | 42 | -61553 | 47 |
| -60126 | 68 | -61131 | 33 | -61382 | 42 | -61600 | 49 |
| -60150 | 68 | -61132 | 33 | -61383 | 42 | -61601 | 49 |
| -60151 | 68 | -61160 | 34 | -61384 | 42 | -61602 | 49 |
| -60152 | 68 | -61161 | 34 | -61385 | 42 | -61603 | 49 |
| -60153 | 68 | -61162 | 34 | -61386 | 42 | -61604 | 49 |
| -60154 | 68 | -61163 | 34 | -61387 | 42 | -61605 | 49 |
| -60155 | 68 | -61164 | 34 | -61388 | 42 | -61606 | 49 |

Cat.No. Index

| | | | | | | | |
|--------|----|--------|----|--------|----|--------|----|
| -61607 | 49 | -62012 | 27 | -62751 | 22 | -63641 | 52 |
| -61608 | 49 | -62040 | 30 | -62752 | 22 | -63642 | 52 |
| -61609 | 49 | -62041 | 30 | -62753 | 22 | -63643 | 52 |
| -61610 | 49 | -62042 | 30 | -62754 | 22 | -63651 | 53 |
| -61611 | 49 | -62043 | 30 | -62755 | 22 | -63652 | 53 |
| -61612 | 49 | -62044 | 30 | -62760 | 22 | -63653 | 53 |
| -61620 | 51 | -62045 | 30 | -62761 | 22 | -63661 | 48 |
| -61621 | 51 | -62046 | 30 | -62762 | 22 | -63662 | 48 |
| -61622 | 51 | -62047 | 30 | -62763 | 22 | -63663 | 48 |
| -61623 | 51 | -62048 | 30 | -62764 | 22 | -64001 | 27 |
| -61624 | 51 | -62049 | 30 | -62765 | 22 | -64002 | 27 |
| -61625 | 51 | -62050 | 30 | -63001 | 26 | -64003 | 27 |
| -61626 | 51 | -62051 | 30 | -63002 | 26 | -64041 | 30 |
| -61627 | 51 | -62052 | 30 | -63003 | 26 | -64042 | 30 |
| -61628 | 51 | -62340 | 39 | -63021 | 28 | -64043 | 30 |
| -61629 | 51 | -62341 | 39 | -63022 | 28 | -64341 | 39 |
| -61640 | 52 | -62342 | 39 | -63023 | 28 | -64342 | 39 |
| -61641 | 52 | -62343 | 39 | -63041 | 29 | -64343 | 39 |
| -61642 | 52 | -62344 | 39 | -63042 | 29 | -64601 | 50 |
| -61643 | 52 | -62345 | 39 | -63043 | 29 | -64602 | 50 |
| -61644 | 52 | -62346 | 39 | -63081 | 32 | -64603 | 50 |
| -61645 | 52 | -62347 | 39 | -63082 | 32 | -65000 | 26 |
| -61646 | 52 | -62348 | 39 | -63083 | 32 | -65001 | 26 |
| -61647 | 52 | -62349 | 39 | -63121 | 33 | -65005 | 26 |
| -61648 | 52 | -62350 | 39 | -63122 | 33 | -65006 | 26 |
| -61649 | 52 | -62351 | 39 | -63123 | 33 | -65020 | 28 |
| -61650 | 52 | -62352 | 39 | -63161 | 34 | -65021 | 28 |
| -61651 | 52 | -62600 | 50 | -63162 | 34 | -65025 | 28 |
| -61652 | 52 | -62601 | 50 | -63163 | 34 | -65026 | 28 |
| -61654 | 52 | -62602 | 50 | -63181 | 35 | -65040 | 29 |
| -61655 | 52 | -62603 | 50 | -63182 | 35 | -65041 | 29 |
| -61700 | 53 | -62604 | 50 | -63183 | 35 | -65045 | 29 |
| -61701 | 53 | -62605 | 50 | -63301 | 36 | -65046 | 29 |
| -61702 | 53 | -62606 | 50 | -63302 | 36 | -65080 | 32 |
| -61703 | 53 | -62607 | 50 | -63303 | 36 | -65081 | 32 |
| -61704 | 53 | -62608 | 50 | -63321 | 37 | -65120 | 33 |
| -61705 | 53 | -62609 | 50 | -63322 | 37 | -65121 | 33 |
| -61706 | 53 | -62610 | 50 | -63323 | 37 | -65160 | 34 |
| -61707 | 53 | -62611 | 50 | -63341 | 38 | -65161 | 34 |
| -61708 | 53 | -62612 | 50 | -63342 | 38 | -65180 | 35 |
| -61709 | 53 | -62690 | 21 | -63343 | 38 | -65181 | 35 |
| -61710 | 53 | -62691 | 21 | -63361 | 40 | -65200 | 31 |
| -61711 | 53 | -62692 | 21 | -63362 | 40 | -65201 | 31 |
| -61712 | 53 | -62693 | 21 | -63363 | 40 | -65205 | 31 |
| -61713 | 53 | -62700 | 21 | -63381 | 42 | -65300 | 36 |
| -61720 | 48 | -62701 | 21 | -63382 | 42 | -65301 | 36 |
| -61721 | 48 | -62702 | 21 | -63383 | 42 | -65320 | 37 |
| -61722 | 48 | -62703 | 21 | -63401 | 41 | -65321 | 37 |
| -61723 | 48 | -62704 | 21 | -63402 | 41 | -65325 | 37 |
| -61724 | 48 | -62705 | 21 | -63403 | 41 | -65340 | 38 |
| -61725 | 48 | -62706 | 21 | -63421 | 43 | -65341 | 38 |
| -61726 | 48 | -62710 | 23 | -63422 | 43 | -65345 | 38 |
| -61727 | 48 | -62711 | 23 | -63423 | 43 | -65360 | 40 |
| -61728 | 48 | -62712 | 23 | -63441 | 44 | -65361 | 40 |
| -61729 | 48 | -62713 | 23 | -63442 | 44 | -65362 | 40 |
| -61730 | 48 | -62720 | 23 | -63443 | 44 | -65380 | 42 |
| -61731 | 48 | -62721 | 23 | -63444 | 44 | -65381 | 42 |
| -61732 | 48 | -62722 | 23 | -63501 | 45 | -65382 | 42 |
| -61733 | 48 | -62723 | 23 | -63502 | 45 | -65400 | 41 |
| -62000 | 27 | -62724 | 23 | -63503 | 45 | -65401 | 41 |
| -62001 | 27 | -62725 | 23 | -63521 | 46 | -65402 | 41 |
| -62002 | 27 | -62726 | 23 | -63522 | 46 | -65403 | 41 |
| -62003 | 27 | -62730 | 20 | -63523 | 46 | -65420 | 43 |
| -62004 | 27 | -62731 | 20 | -63541 | 47 | -65421 | 43 |
| -62005 | 27 | -62732 | 20 | -63542 | 47 | -65422 | 43 |
| -62006 | 27 | -62733 | 20 | -63543 | 47 | -65440 | 44 |
| -62007 | 27 | -62740 | 20 | -63601 | 49 | -65441 | 44 |
| -62008 | 27 | -62741 | 20 | -63602 | 49 | -65442 | 44 |
| -62009 | 27 | -62742 | 20 | -63603 | 49 | -65500 | 45 |
| -62010 | 27 | -62743 | 20 | -63621 | 51 | -65501 | 45 |
| -62011 | 27 | -62744 | 20 | -63622 | 51 | -65520 | 46 |
| | | -62750 | 22 | -63623 | 51 | | |

| | |
|--------|----|
| -65521 | 46 |
| -65540 | 47 |
| -65541 | 47 |
| -65600 | 49 |
| -65601 | 49 |
| -65605 | 49 |
| -65620 | 51 |
| -65621 | 51 |
| -65640 | 52 |
| -65641 | 52 |
| -65650 | 53 |
| -65651 | 53 |
| -65660 | 48 |
| -65661 | 48 |
| -65700 | 58 |
| -65701 | 58 |
| -65710 | 54 |
| -65720 | 13 |
| -65721 | 13 |
| -65726 | 13 |
| -65740 | 15 |
| -65775 | 13 |
| -65780 | 61 |
| -65795 | 12 |
| -65805 | 21 |
| -65815 | 23 |
| -65825 | 20 |
| -65835 | 22 |
| -66000 | 26 |
| -66001 | 26 |
| -66010 | 27 |
| -66011 | 27 |
| -66020 | 28 |
| -66021 | 28 |
| -66030 | 29 |
| -66031 | 29 |
| -66040 | 30 |
| -66041 | 30 |
| -66050 | 32 |
| -66051 | 32 |
| -66070 | 33 |
| -66071 | 33 |
| -66090 | 34 |
| -66091 | 34 |
| -66100 | 35 |
| -66101 | 35 |
| -66230 | 15 |
| -66231 | 15 |
| -66300 | 36 |
| -66301 | 36 |
| -66310 | 37 |
| -66311 | 37 |
| -66320 | 38 |
| -66321 | 38 |
| -66400 | 45 |
| -66401 | 45 |
| -66410 | 46 |
| -66411 | 46 |
| -66420 | 47 |
| -66421 | 47 |
| -66430 | 48 |
| -66431 | 48 |
| -66440 | 12 |
| -66441 | 12 |
| -66442 | 12 |
| -66450 | 12 |
| -66460 | 21 |
| -66461 | 21 |
| -66462 | 21 |
| -66465 | 21 |
| -66466 | 21 |

| | |
|--------|----|
| -66470 | 23 |
| -66471 | 23 |
| -66480 | 20 |
| -66481 | 20 |
| -66482 | 20 |
| -66486 | 20 |
| -66490 | 22 |
| -66491 | 22 |
| -66492 | 22 |
| -66500 | 18 |
| -66501 | 18 |
| -66510 | 19 |
| -66511 | 19 |
| -66600 | 49 |
| -66601 | 49 |
| -66610 | 51 |
| -66611 | 51 |
| -66620 | 52 |
| -66621 | 52 |
| -66640 | 53 |
| -66641 | 53 |
| -66700 | 16 |
| -66701 | 16 |
| -66710 | 17 |
| -66711 | 17 |
| -66800 | 24 |
| -66801 | 24 |
| -68000 | 54 |
| -68001 | 54 |
| -68002 | 54 |
| -68003 | 54 |
| -68004 | 54 |
| -68005 | 54 |
| -68006 | 54 |
| -68007 | 54 |
| -68011 | 55 |
| -68012 | 55 |
| -68013 | 55 |
| -68014 | 55 |
| -68015 | 55 |
| -68016 | 55 |
| -68017 | 55 |
| -68020 | 55 |
| -68022 | 55 |
| -68023 | 55 |
| -68024 | 55 |
| -68025 | 55 |
| -68034 | 56 |
| -68044 | 56 |
| -68054 | 57 |
| -68100 | 56 |
| -68101 | 56 |
| -68104 | 56 |
| -68105 | 56 |
| -68110 | 58 |
| -68111 | 58 |
| -68114 | 57 |
| -68120 | 58 |
| -68121 | 58 |
| -68125 | 59 |
| -68127 | 59 |
| -68133 | 57 |
| -68140 | 60 |
| -68141 | 60 |
| -68142 | 60 |
| -68150 | 60 |
| -68151 | 60 |
| -68152 | 60 |
| -68153 | 60 |
| -68154 | 60 |
| -68208 | 59 |

| | |
|--------|----|
| -68209 | 59 |
| -68210 | 59 |
| -68218 | 59 |
| -68219 | 59 |
| -68220 | 59 |
| -69000 | 26 |
| -69001 | 28 |
| -69002 | 29 |
| -69003 | 32 |
| -69005 | 33 |
| -69007 | 34 |
| -69008 | 35 |
| -69009 | 36 |
| -69010 | 37 |
| -69011 | 38 |
| -69012 | 40 |
| -69013 | 42 |
| -69014 | 41 |
| -69015 | 43 |
| -69016 | 44 |
| -69017 | 45 |
| -69018 | 46 |
| -69019 | 47 |
| -69020 | 49 |
| -69021 | 51 |
| -69022 | 52 |
| -69024 | 27 |
| -69026 | 30 |
| -69030 | 39 |
| -69031 | 50 |
| -69033 | 53 |
| -69034 | 48 |
| -69050 | 54 |
| -69051 | 54 |
| -69100 | 13 |
| -69101 | 13 |
| -69102 | 13 |
| -69103 | 13 |
| -69112 | 15 |
| -69113 | 15 |
| -69114 | 15 |
| -69115 | 15 |
| -69116 | 16 |
| -69117 | 16 |
| -69118 | 17 |
| -69119 | 17 |
| -69120 | 18 |
| -69121 | 18 |
| -69122 | 19 |
| -69123 | 19 |
| -69126 | 24 |
| -69127 | 24 |
| -69128 | 25 |
| -69129 | 25 |
| -69130 | 12 |
| -69131 | 12 |
| -69132 | 12 |
| -69133 | 12 |
| -69134 | 21 |
| -69135 | 21 |
| -69136 | 23 |
| -69137 | 23 |
| -69138 | 20 |
| -69139 | 20 |
| -69140 | 22 |
| -69141 | 22 |
| -69500 | 59 |

5020

| | |
|--------|----|
| -75000 | 90 |
|--------|----|

| | |
|--------|----|
| -75010 | 90 |
|--------|----|

5040

| | |
|--------|----|
| -29001 | 76 |
| -29002 | 76 |
| -29003 | 76 |
| -29004 | 76 |
| -29005 | 76 |
| -29006 | 76 |
| -29007 | 76 |
| -29008 | 76 |
| -29009 | 76 |
| -29010 | 76 |
| -29011 | 76 |
| -29012 | 76 |
| -29013 | 76 |
| -29014 | 76 |
| -29015 | 76 |
| -29016 | 76 |

6045

| | |
|--------|----|
| -11000 | 67 |
|--------|----|

7510

| | |
|--------|----|
| -11021 | 79 |
| -11037 | 79 |
| -11202 | 94 |
| -11203 | 94 |
| -11302 | 83 |
| -11310 | 89 |
| -11311 | 89 |
| -11312 | 89 |
| -11313 | 89 |
| -11314 | 89 |
| -11315 | 89 |
| -11316 | 89 |
| -11317 | 89 |
| -11320 | 84 |
| -11321 | 84 |
| -11322 | 84 |
| -11323 | 84 |
| -11324 | 84 |
| -11325 | 84 |
| -11326 | 84 |

7820

| | |
|--------|----|
| -11001 | 79 |
| -11005 | 79 |
| -11011 | 79 |
| -11015 | 79 |
| -11200 | 94 |
| -11201 | 94 |

GL Sciences disclaims any and all responsibility for any injury or damage which may be caused by this data directly or indirectly.

We reserve the right to amend this information or data at any time and without any prior announcement. Please note that, in the interests of continuous improvement, models or specifications are subject to change without notice. Please also note that the company name and product name appearing in this catalogue are the trademark or registered trademark of each corresponding company. In the descriptions in this catalogue, TM and R marks are not used.

GL Sciences Inc. Japan

22-1 Nishishinjuku 6-chome
Shinjuku-ku, Tokyo
163-1130, Japan

Phone : +81-3-5323-6620

Fax : +81-3-5323-6621

Email : world@glsciences.co.jp

Web : www.glsciences.com

GL Sciences Inc. USA

4733 Torrance Blvd. Suite 255
Torrance, CA 90503
USA

Phone : +1-310-265-4424

Fax : +1-310-265-4425

Email : info@glsciencesinc.com

Web : www.glsciencesinc.com

GL Sciences B.V.

Dillenburgstraat 7C
5652AM, Eindhoven
The Netherlands

Phone : +31-40-254-9531

Email : info@glsciences.eu

Web : www.glsciences.eu

GL Sciences (Shanghai) Limited

Tower B, Room 2003
Far East International Plaza
No.317 Xianxia Road, Changning District
Shanghai, China 200051

Phone : +86-21-62782272

Email : contact@glsciences.com.cn

Web : www.glsciences.com.cn



International Distributors

Visit our Website at www.glsciences.com/distributors



Published in Japan, March 15, 2023
EN1074-20230315DN0.5T